

C.A 6522 C.A 6524 C.A 6526















Megohmmeters

Thank you for purchasing a **megohmmeter C.A 6522, C.A 6524 or C.A 6526.**

For best results from your instrument:

- **read** these operating instructions carefully,
- **comply** with the precautions for use.

	WARNING, risk of DANGER! The operator must refer to these instructions whenever this danger symbol appears.
	WARNING, risk of electric shock. The voltage applied to parts marked with this symbol may be hazardous.
	Equipment protected by double insulation.
	The voltage on the terminals must not exceed 700 V.
	Remote control probe.
	Earth.
	Battery.
	Information or useful tip.
	The product is declared recyclable following an analysis of the life cycle in accordance with standard ISO14040.
	Chauvin Arnoux has adopted an Eco-Design approach in order to design this appliance. Analysis of the complete lifecycle has enabled us to control and optimize the effects of the product on the environment. In particular this appliance exceeds regulation requirements with respect to recycling and reuse.
	The CE marking indicates conformity with European directives, in particular LVD and EMC.
	The rubbish bin with a line through it indicates that, in the European Union, the product must undergo selective disposal in compliance with Directive WEEE 2002/96/EC. This equipment must not be treated as household waste.

Definition of measurement categories:

- Measurement category IV corresponds to measurements taken at the source of low-voltage installations.
Example: power feeders, counters and protection devices.
- Measurement category III corresponds to measurements on building installations.
Example: distribution panel, circuit-breakers, machines or fixed industrial devices
- Measurement category II corresponds to measurements taken on circuits directly connected to low-voltage installations.
Example: power supply to electro-domestic devices and portable tools.

PRECAUTIONS FOR USE

This instrument is compliant with safety standard IEC 61010-2-030 and the leads are compliant with IEC 61010-031, for voltages up to 600 V in category IV or 1,000 V in category III.

Failure to observe the safety instructions may result in electric shock, fire, explosion, and destruction of the instrument and of the installations.

- The operator and/or the responsible authority must carefully read and clearly understand the various precautions to be taken in use. Sound knowledge and a keen awareness of electrical hazards are essential when using this instrument.
- If you use this instrument other than as specified, the protection it provides may be compromised, thereby endangering you.
- The safety of any system in which this instrument might be incorporated is the responsibility of the integrator of the system.
- This instrument can be used on category IV installations, for voltages not exceeding 600 V_{RMS} with respect to earth or 700 V_{RMS} max between terminals.
- Do not use the instrument on networks of which the voltage or category exceeds those mentioned.
- Observe the environmental conditions of use.
- Except for voltage measurements, make no measurements on live devices.
- Do not use the instrument if it seems to be damaged, incomplete, or poorly closed.
- Before each use, check the condition of the insulation on the leads, housing, and accessories. Any item of which the insulation is deteriorated (even partially) must be set aside for repair or scrapping. There is a risk of electric shock if the instrument is used without its battery compartment cover.
- Before using your instrument, check that it is perfectly dry. If it is wet, it must be thoroughly dried before it can be connected or used.
- Use only the leads and accessories supplied. The use of leads (or accessories) of a lower voltage rating or category limits the use of the combined instrument + leads (or accessories) to the lowest category and service voltage.
- When handling the leads, test probes, and crocodile clips, keep your fingers behind the physical guard.
- Before removing of the battery compartment cover, make sure that the measurement leads (and accessories) are disconnected. Replace all of the batteries at once. Use alkaline batteries.
- Use personal protection equipment systematically.
- All troubleshooting and metrological checks must be done by competent, accredited personnel.

CONTENTS

1. PRESENTATION	5
1.1. Delivery condition	5
1.2. Accessories	6
1.3. Replacement parts	6
1.4. Description of the instruments	7
1.5. Terminal block	11
1.6. Functions of the instrument	11
1.7. TEST button	11
1.8. Function keys	12
1.9. Display	12
2. USE	13
2.1. General	13
2.2. Voltage measurement	13
2.3. Insulation measurement	14
2.4. Continuity measurement	17
2.5. Resistance measurement (C.A 6524 and C.A 6526)	19
2.6. Capacitance measurement (C.A 6526)	19
2.7. ΔREL function (C.A 6524 and C.A 6526)	19
2.8. HOLD function	20
2.9. Backlighting	20
2.10. SET-UP	21
2.11. Alarm function	22
2.12. Automatic stop	23
2.13. Storage (C.A 6524 and C.A 6526)	23
2.14. Bluetooth communication (C.A 6526)	25
2.15. Errors	27
2.16. Resetting the instrument	28
3. TECHNICAL CHARACTERISTICS	29
3.1. General reference conditions	29
3.2. Electrical characteristics	29
3.3. Variation in the range of use	32
3.4. Intrinsic uncertainty and operating uncertainty	34
3.5. Power supply	34
3.6. Environmental conditions	34
3.7. Mechanical characteristics	34
3.8. Compliance with international standards	34
3.9. Electromagnetic compatibility (CEM)	34
4. MAINTENANCE	35
4.1. Cleaning	35
4.2. Replacing the batteries	35
5. WARRANTY	36

1. PRESENTATION

1.1. DELIVERY CONDITION

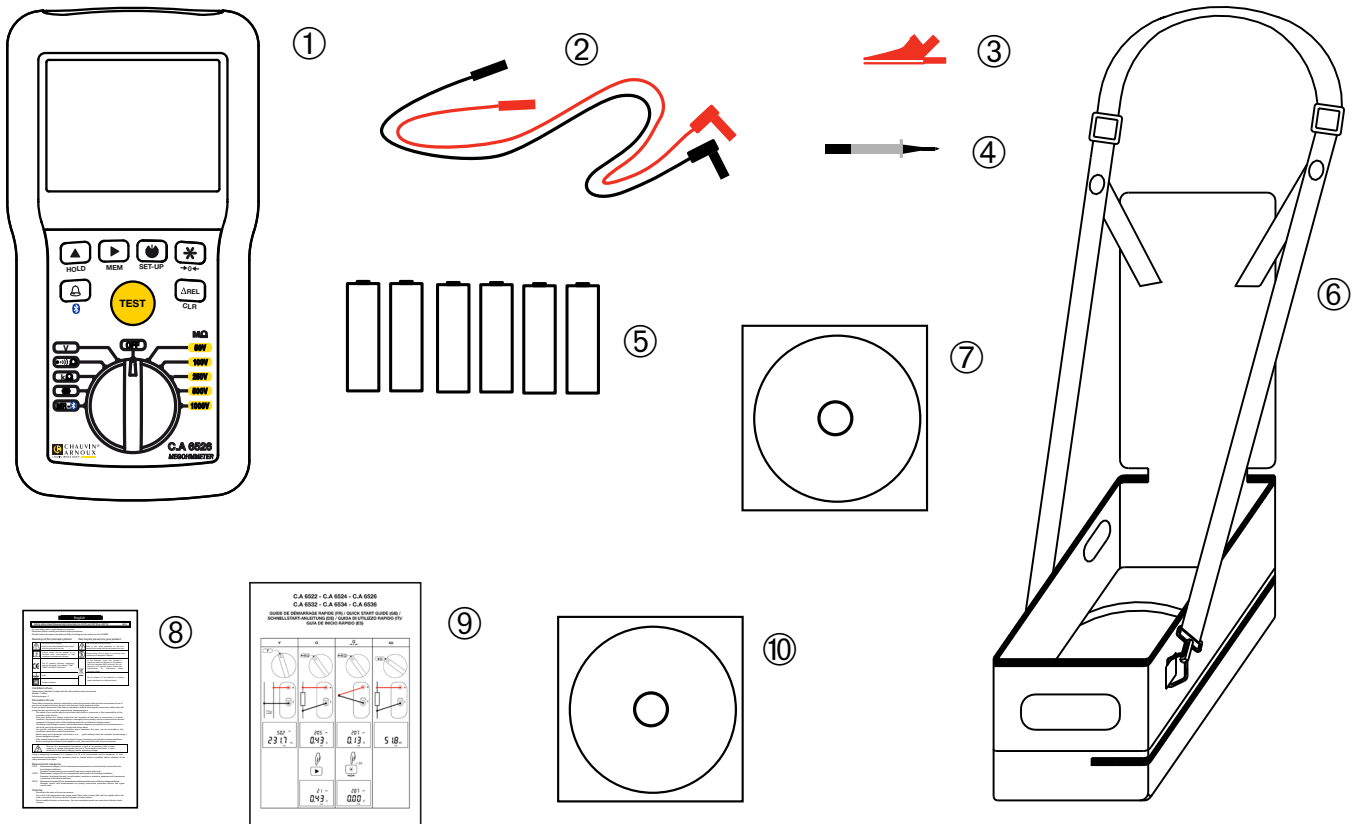

- ① One C.A 6522, C.A 6524, or C.A 6526, depending on which model was ordered.
- ② Two straight/right-angle safety leads (red and black).
- ③ One red crocodile clip.
- ④ One black test probe.
- ⑤ Six LR6 or AA batteries.
- ⑥ One carrying case, which also allows hands-free use.
- ⑦ One CD containing the user manuals (one file per language).
- ⑧ One multilingual safety data sheet.
- ⑨ One multilingual getting started guide.
- ⑩ One CD containing the MEG software for the C.A 6526.

1.2. ACCESSORIES

Type 3 remote control probe

Continuity pole

Thermometer + K thermocouple, C.A 861

Thermo-hygrometer C.A 846

USB-Bluetooth adapter

DataView® software

1.3. REPLACEMENT PARTS

2 straight/right-angle safety leads (red and black) 1.50 m long

2 crocodile clips (red and black)

2 test probes (red and black)

Carrying case that also allows hands-free use

For accessories and spare parts, visit our website:

www.chauvin-arnoux.com

1.4. DESCRIPTION OF THE INSTRUMENTS

1.4.1. C.A 6522

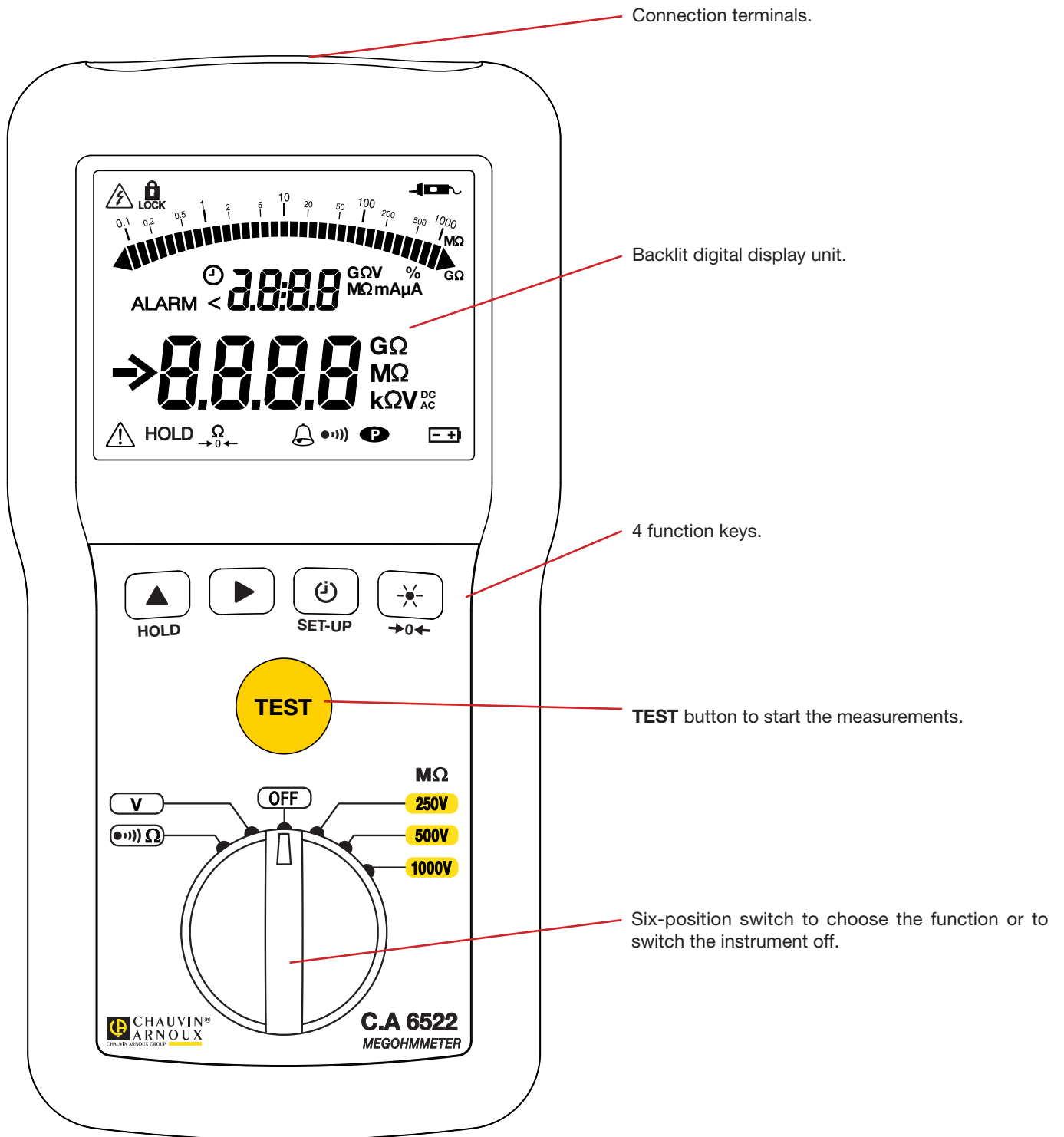

1.4.2. C.A 6524

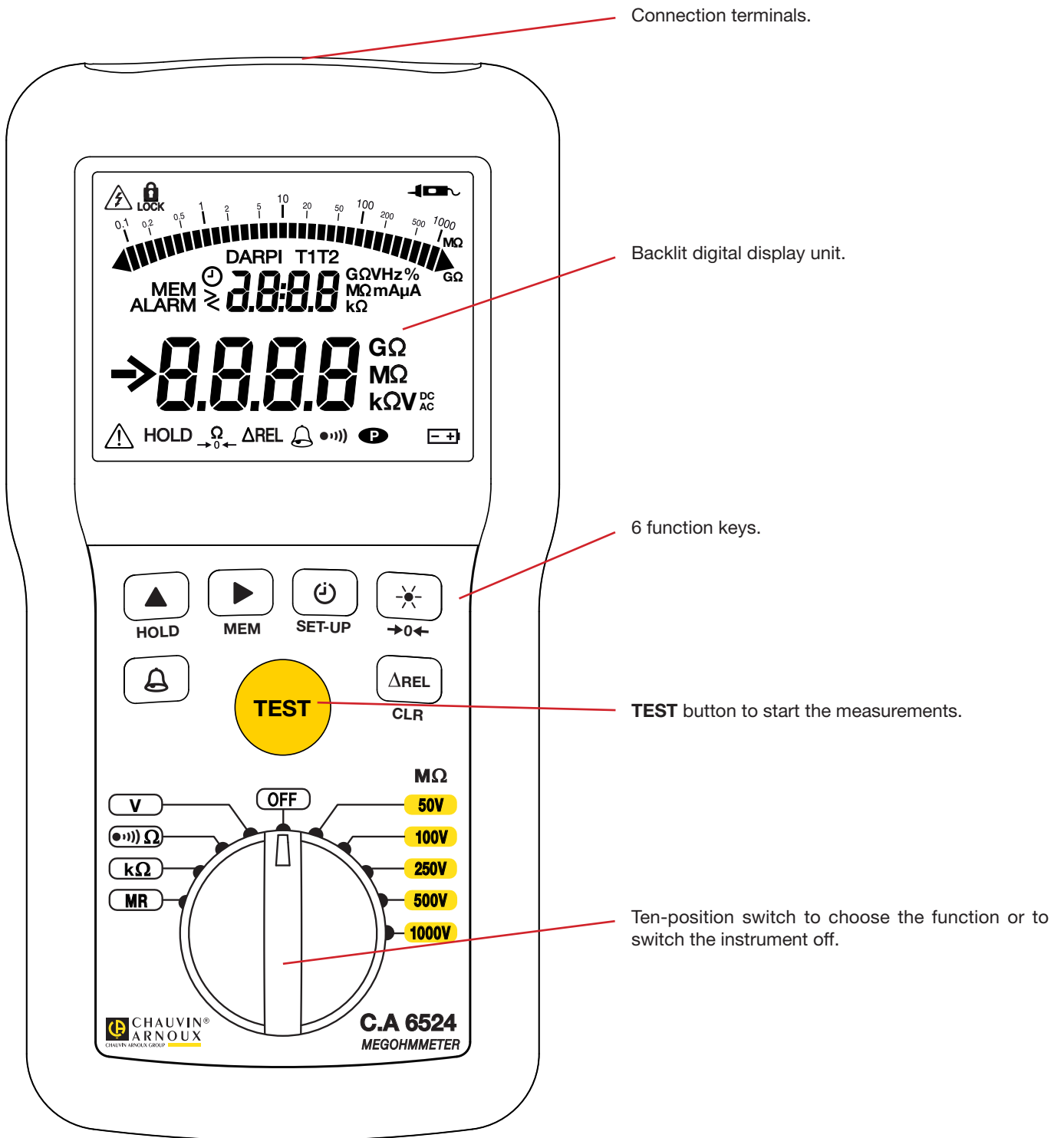

1.4.3. C.A 6526

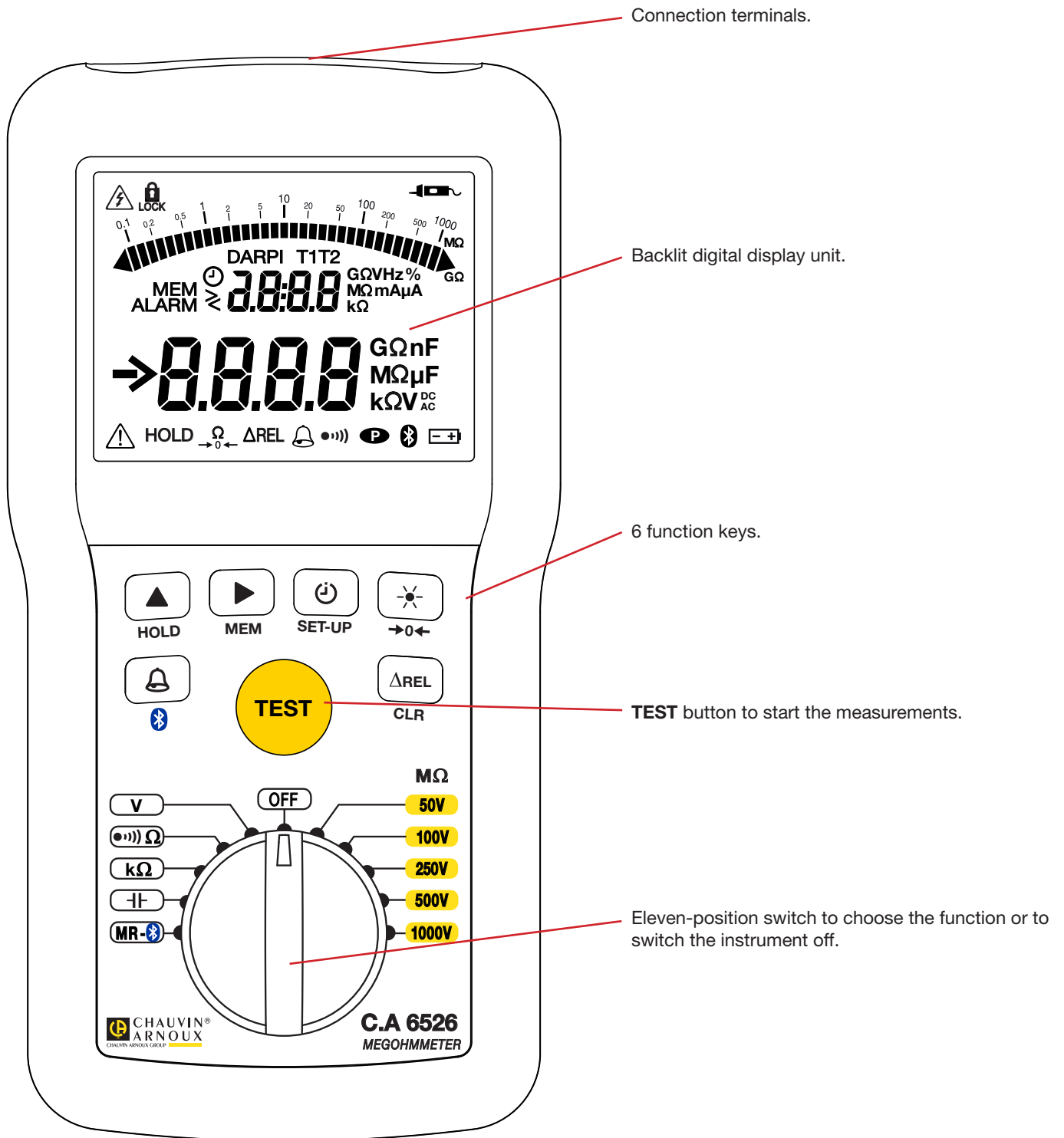

1.4.4. ON THE BACK

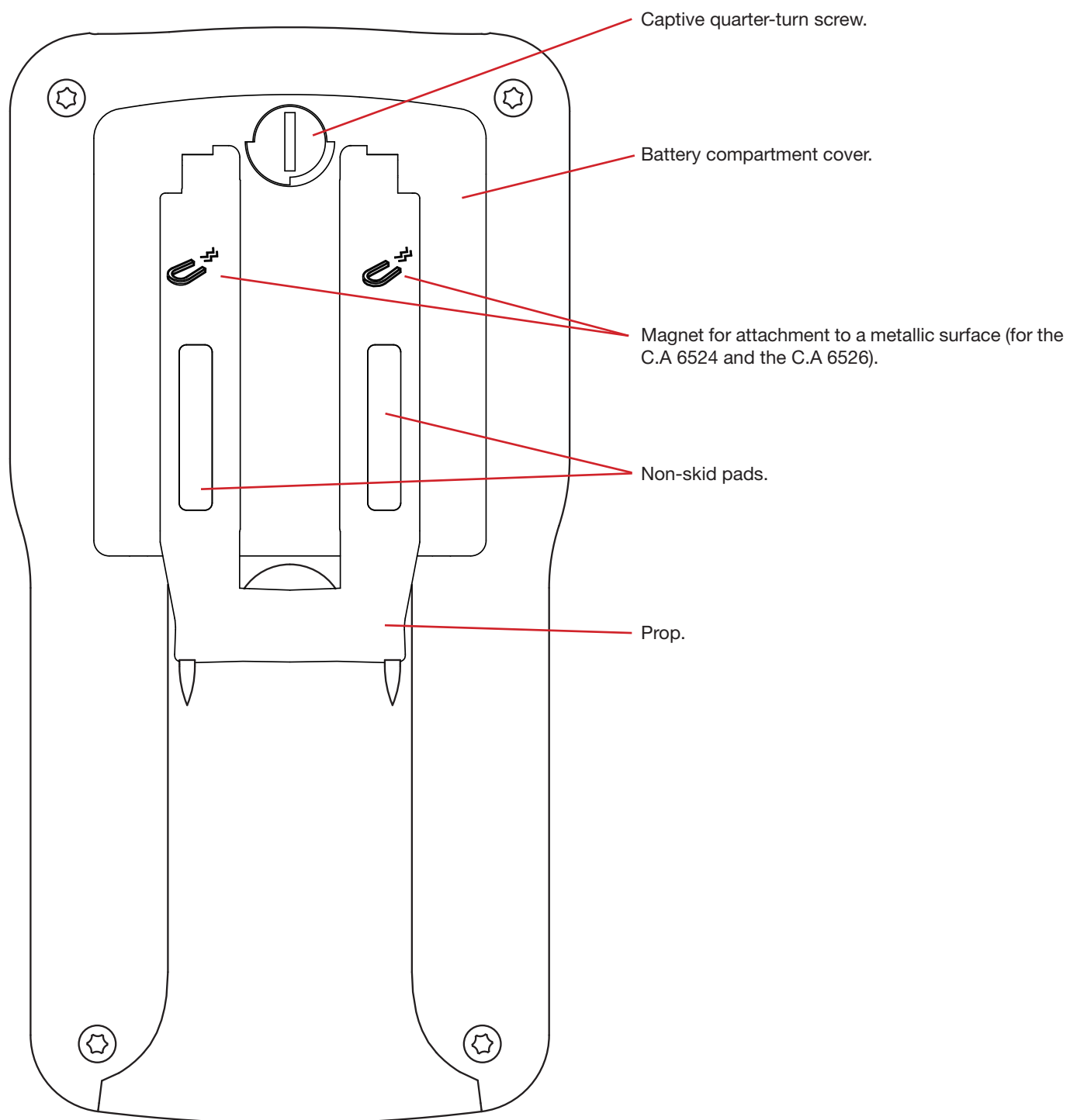

1.5. TERMINAL BLOCK

The terminal block has one + terminal and one - terminal that can be used to connect the remote control probe (optional accessory).

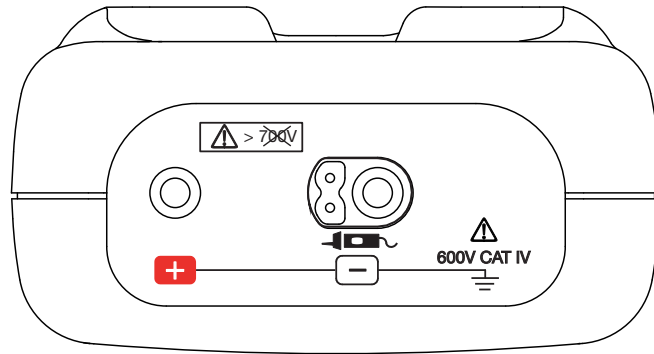

1.6. FUNCTIONS OF THE INSTRUMENT

C.A 6522, C.A 6524, and C.A 6526 megohmmeters are portable measuring instruments with digital displays. They are powered by batteries.

These instruments are used to check the safety of electrical installations. They are used to test new installations before they are powered up, to check an existing installation in a power-off condition, or again to troubleshoot an installation.

	C.A 6522	C.A 6524	C.A 6526
Test voltages for insulation measurements	250V - 500V - 1,000V	50V - 100V - 250V - 500V - 1,000V	50V - 100V - 250V - 500V - 1,000V
Calculation of ratios PI and DAR	✘	✔	✔
Continuity measurement	✔	✔	✔
Resistance measurement	✘	✔	✔
Programmable alarms	✘	✔	✔
Frequency measurement	✘	✔	✔
Capacitance measurement	✘	✘	✔
Storage of the measurements	✘	✔	✔
Bluetooth	✘	✘	✔

In continuity testing, the instruments are protected against external voltages without a fuse.

1.7. TEST BUTTON

The **TEST** button is used to make insulation measurements.

1.8. FUNCTION KEYS

In general, the keys have a first function, marked on the key, obtained by a short press, and a second function, marked under the key, obtained by a long press.

Key	Function
	The TIMER key is used to select the LOCK, , PI, and DAR functions.
	The key is used to switch the display unit backlighting on and off.
HOLD	The HOLD key is used to freeze, then unfreeze, the display of the measurement.
SET-UP	The SET-UP key is used to access the parameters and information of the instrument.
	The key is used to apply compensation for the resistance of the measurement leads in continuity testing.
	On the C.A 6524 and C.A 6526, the ALARM key is used to activate or deactivate the alarms. On the C.A 6526, the ALARM key has a two-colour (green and red) indicator to report overshoots of alarm thresholds.
	The keys serve: <ul style="list-style-type: none"> ■ to modify the display and to program the durations of insulation measurements, ■ to choose the continuity test current, ■ and to program the alarm thresholds (on the C.A 6524 and C.A 6526).
ΔRel	On the C.A 6524 and C.A 6526, the ΔRel key is used to display the measurement from which a stored reference measurement is subtracted.
MEM	On the C.A 6524 and C.A 6526, the MEM key is used to record measurements.
CLR	On the C.A 6524 and C.A 6526, the CLR key is used to erase recorded measurements.
	On the C.A 6526, the Bluetooth key is used to transfer data recorded in the memory of the instrument to a computer using the Bluetooth wireless connection. The Bluetooth link also serves to start insulation measurements from the PC.

1.9. DISPLAY

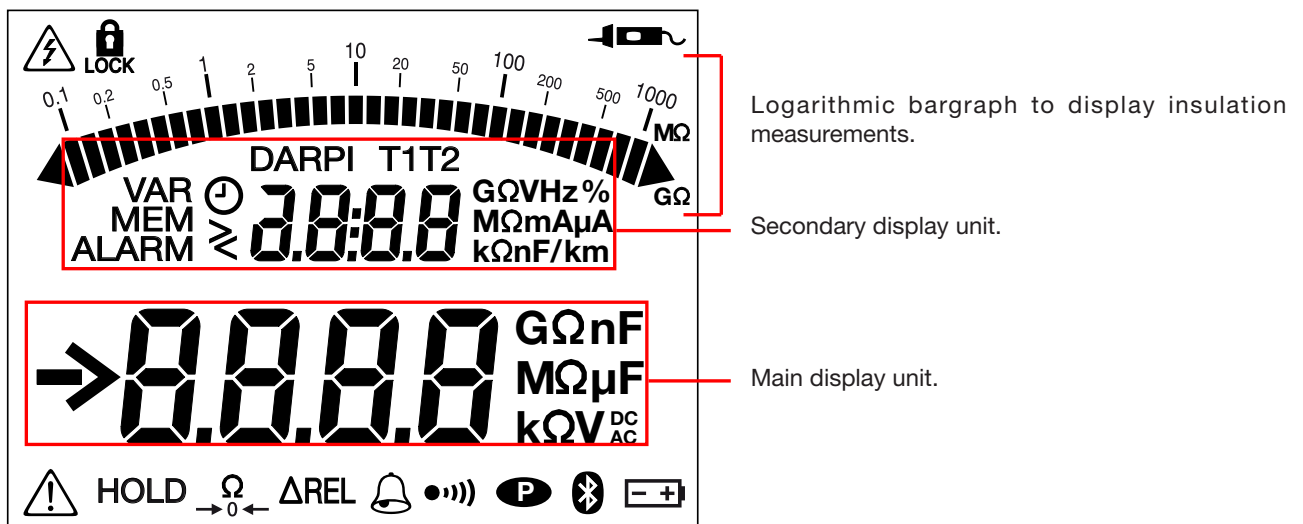

When the measured value is below the minimum, the instrument displays - - - - .

In voltage measurement, when the measurement exceeds the limit (either positive or negative), the instrument displays OL or -OL.

2. USE

2.1. GENERAL

At start-up, the instrument indicates the remaining battery life.

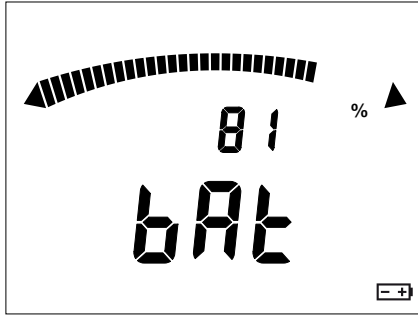

If the battery voltage is too low to ensure correct operation of the instrument, it so reports.



The batteries must then be replaced (see § 4.2), since the battery life indication is no longer reliable.



Except for the voltage measurement, all measurements are made on devices in the power-off condition. It is therefore necessary to check that there is no voltage on the device to be tested before making a measurement.

2.2. VOLTAGE MEASUREMENT

Set the switch to **V** or to one of the **MΩ** positions.

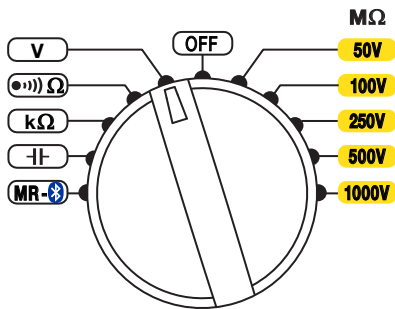

Start by making sure of the proper operation of the voltage measurement, by measuring a known voltage before each use. For example on a power outlet.

Then, using the leads, connect the device to be tested to the terminals of the instrument.

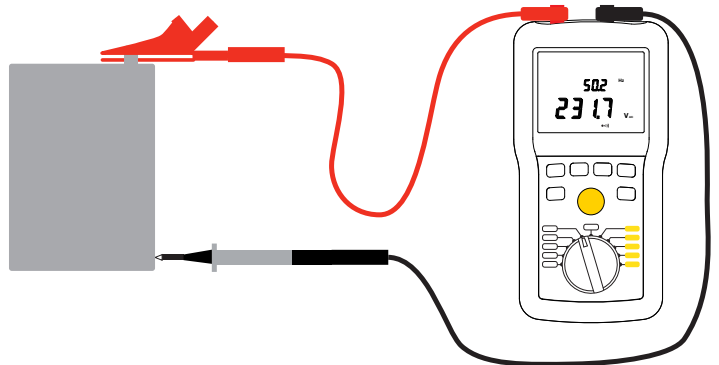

The instrument displays the voltage on the terminals. It detects whether the voltage is AC or DC and, if it is AC, displays its frequency (on the C.A 6524 and the C.A 6526).



In the MΩ settings, the  symbol indicates that the voltage is too high (> 25 V) and that insulation measurements are prohibited.

If the voltage is > 15 V, continuity, resistance, and capacitance measurements are prohibited.

2.3. INSULATION MEASUREMENT

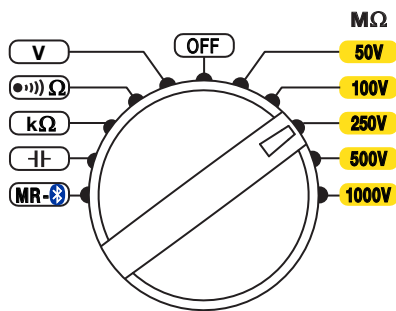

Set the switch to one of the **MΩ** positions.

The test voltage you should choose depends on the voltage of the installation to be tested. For example, for a network installation at 230 V, insulation measurements will be made at 500 V.

Use the leads to connect the device to be tested to the terminals of the instrument. The device to be tested must not be live.

Pressing the **▶** key, before or during the measurement, changes the secondary display unit to display the current (on the C.A 6524 and C.A 6526) or the elapsed time.

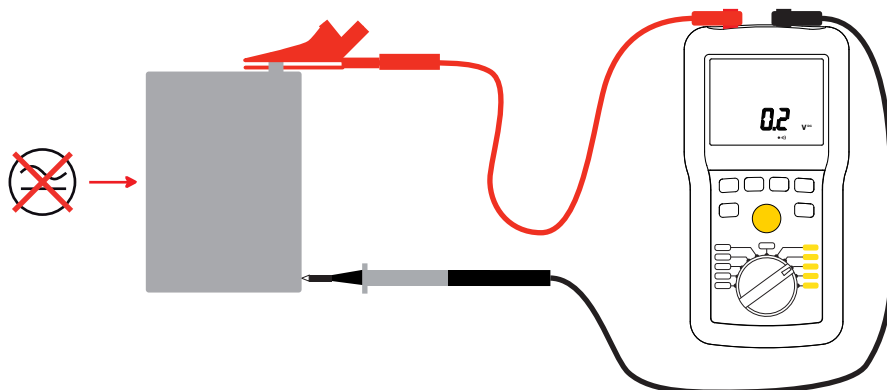



Press the **TEST** button and hold it down until the measurement displayed is stable. If a voltage greater than 25 V is detected, pressing the **TEST** button has no effect.

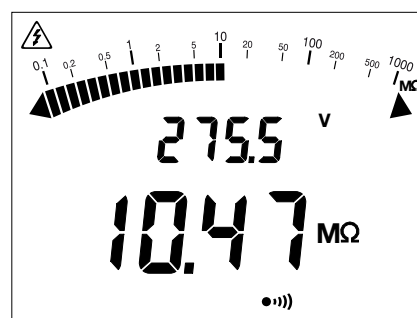
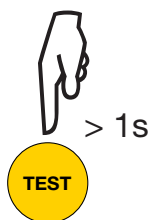

The measurement is displayed on the main display unit and on the bargraph. The secondary display unit indicates the test voltage generated by the instrument.



The  symbol indicates that the instrument is generating a hazardous voltage (> 70 V).

 The measurement results can be thrown off by the impedances of additional circuits connected in parallel or by transient currents.

At the end of the measurement, release the **TEST** button. The instrument stops generating the test voltage and discharges the device being tested. The  symbol is displayed until the voltage on the device has fallen below 70 V.

 Do not disconnect the leads and do not start any measurement while the symbol  is displayed.

When you release the **TEST** button, the measurement results remain displayed (**HOLD**) until the next measurement, or the **HOLD** key is pressed, or the instrument is switched off.

2.3.1. OPERATION OF THE TEST BUTTON



The **TEST** button is pressed to make an insulation measurement. The test voltage is generated for as long as the press is maintained. When the button is released, the measurement stops.

In the **lock** mode, simply press the **TEST** button once to start the measurement, then press it a second time to stop; there is no need to keep the button pressed. However, if you forget to stop the measurement, it will stop automatically after 15 minutes.

In the timed test mode (⌚, DAR, PI), simply press the **TEST** button once to start the measurement; it will stop automatically at the end of the programmed time.

2.3.2. TIMER KEY ⌚

This key is active only for insulation measurements.

1 st press	 LOCK	This function is used to lock the TEST button so as not to have to keep it pressed during the insulation measurement.
2 nd press	 2:00	This function is used to program a test duration between 1 and 39:59 minutes. Use the ▶ and ▲ keys to modify the value displayed. When the time is displayed, press the ▶ key to enter programming mode. When the first digit blinks, you can change it using the ▲ key. Press ▶ to go to the next digit and ▲ to change it. Press ▶ one last time to validate.
3 rd press	PI T2 10:00	The PI function is used to calculate the polarization index, which is the ratio of the measurement at T2 = 10 minutes to the measurement at T1 = 1 minute.
4 th press	DAR T2 1:00	The DAR function is used to calculate the dielectric absorption ratio, which is the ratio of the measurement at T2 = 1 minute to the measurement at T1 = 30 seconds.
5 th press		Exit from the function.

When one of the 3 functions, ⌚, PI, or DAR, is programmed, pressing the **TEST** button triggers the count down from the programmed time. When the time has elapsed, the measurement stops and the result is displayed.



Successive presses on the **▲** key display intermediate values.

For ⌚ :

- the programmed time, the voltage and current at the end of the measurement.

For PI and DAR:

- time T1 and the voltage, current, and insulation resistance at that time.
- time T2 and the voltage, current, and insulation resistance at that time.

Interpretation of the results

DAR	PI	Condition of insulation
$DAR < 1,25$	$PI < 2$	Poor or even dangerous
$1,25 \leq DAR < 1,6$	$2 \leq PI < 4$	Good
$1,6 \leq DAR$	$4 \leq PI$	Excellent





Press the **TEST** key to return to the voltage measurement.

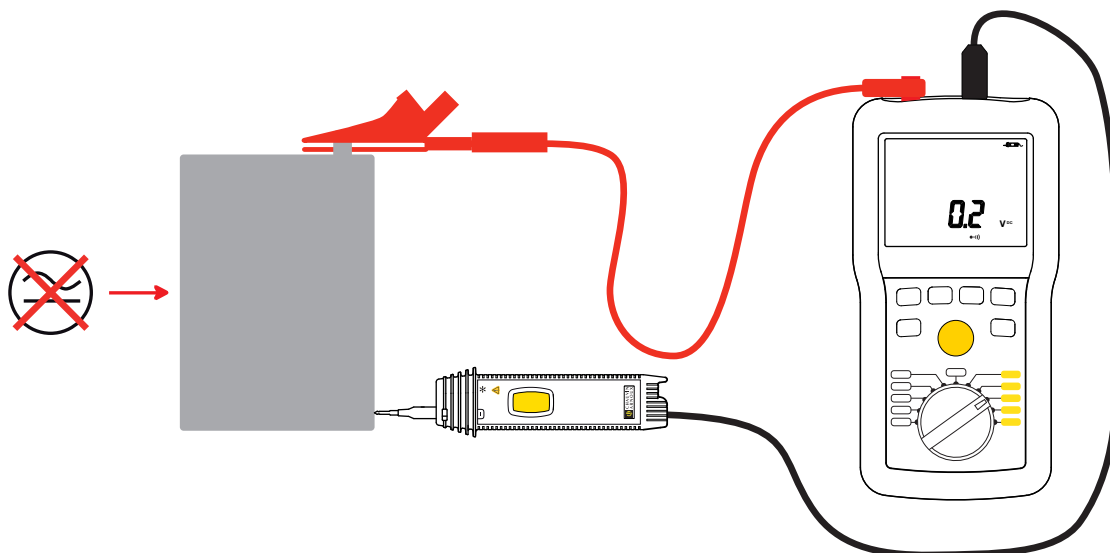

2.3.3. REMOTE CONTROL PROBE (OPTION)

The remote control probe is used to trigger the measurement using the remoted **TEST** button on the probe. To use this accessory, refer to its operating instructions.



When the probe is connected, the  symbol is displayed.

2.4. CONTINUITY MEASUREMENT

The continuity measurement measures a low resistance (< 10 or 100 Ω depending on the current) at a high current (200 or 20 mA).

Set the switch to $\bullet\text{---}\Omega$.

Press the \blacktriangleright key to choose current measurement.

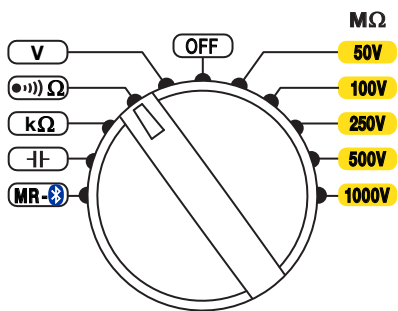

The standard requires that the measurements be made at 200 mA. But a current of 20 mA reduces the consumption of the instrument and so increases its battery life.

The C.A 6522 can make measurements only at 200 mA.

2.4.1. COMPENSATION OF THE LEADS

To ensure precise measurements, it is necessary to compensate the resistance of the measurement leads.

Short-circuit the measurement leads and long-press the $\rightarrow 0 \leftarrow$ key.

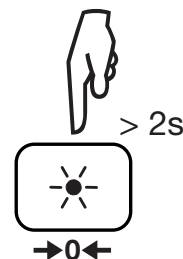
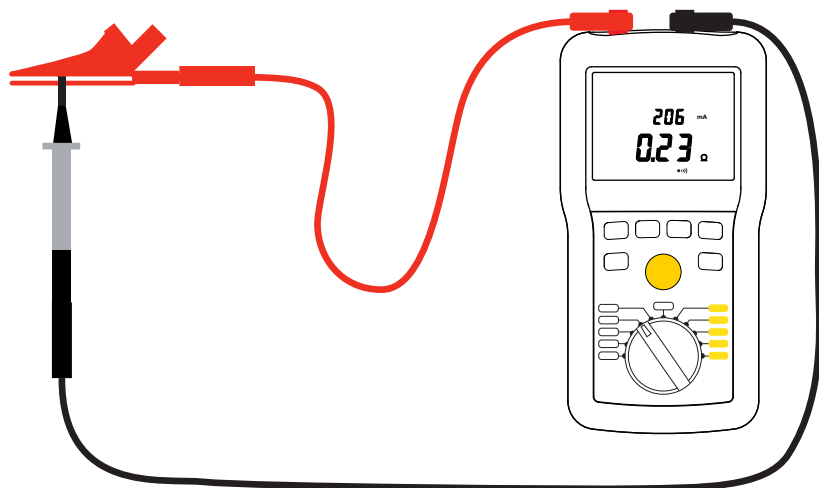

The display changes to zero and the $\rightarrow 0 \leftarrow$ symbol is displayed. The resistance of the leads will be systematically subtracted from all continuity measurements. If the resistance of the leads is > 10 Ω , there is no compensation.



The compensation remains in memory until the instrument is switched off. The continuity measurement range is reduced by the stored compensation value.



If the leads are changed with no change of compensation, the display may become negative. The instrument reports that the compensation must be redone by displaying $\rightarrow 0 \leftarrow$ blinking.

2.4.2. ELIMINATION OF THE COMPENSATION OF THE LEADS

To eliminate the compensation of the leads, leave the leads open and long-press the $\rightarrow 0 \leftarrow$ key.

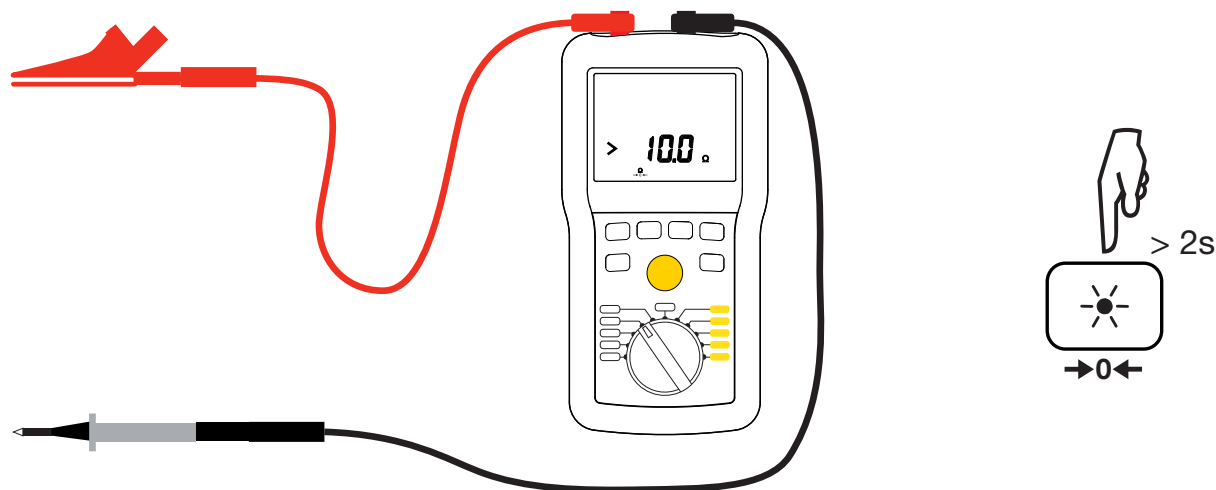

The display indicates the resistance of the leads and the $\rightarrow \Omega \leftarrow$ symbol goes off.

2.4.3. MAKING A MEASUREMENT

Use the leads to connect the device to be tested to the terminals of the instrument. The device to be tested must not be live.

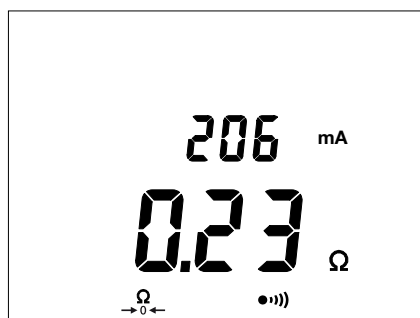
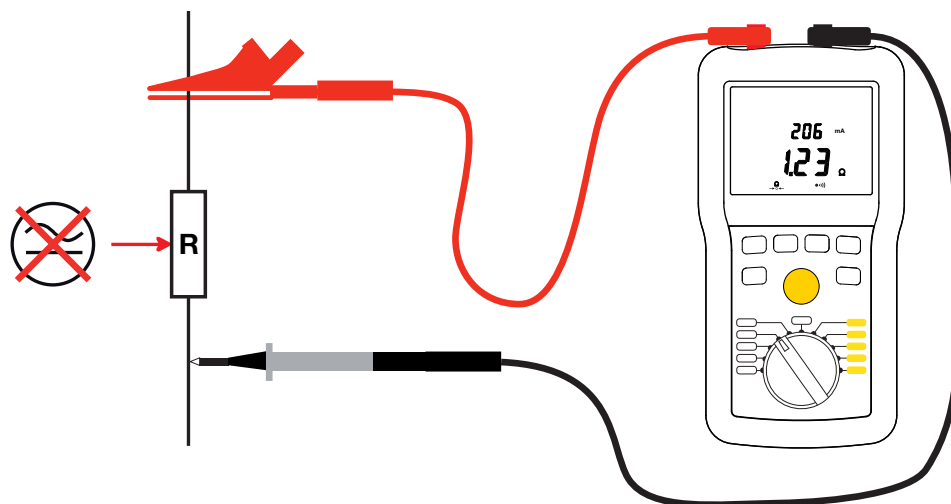

The instrument makes the measurement directly. It displays the result and the measurement current.

To obtain a continuity value per standard IEC 61557:

- Make a measurement at 200 mA and note its value, R_1 .
- Then reverse the leads and note the value R_2 .
- Calculate the mean: $R = \frac{R_1 + R_2}{2}$



If an external voltage > 15 V appears during the continuity measurement, the instrument is protected without a fuse. The continuity measurement is stopped and the instrument reports an error until the voltage disappears.

2.5. RESISTANCE MEASUREMENT (C.A 6524 AND C.A 6526)

The resistance measurement is made with a weak current and can measure resistances up to 1000 kΩ.

Set the switch to **kΩ**.

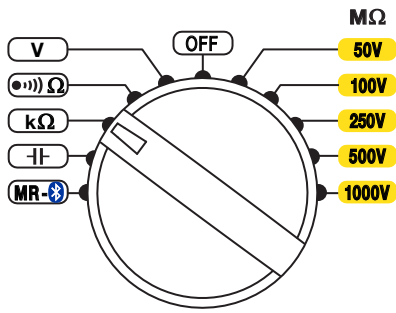

As for a continuity measurement, connect the device to be tested to the terminals of the instrument. The device to be tested must not be live (see § 2.4.3).



2.6. CAPACITANCE MEASUREMENT (C.A 6526)

Set the switch to **⌚**.

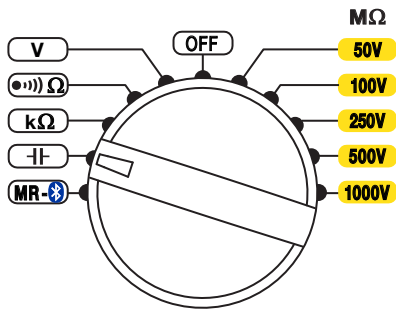

As for a continuity measurement, connect the device to be tested to the terminals of the instrument. The device to be tested must not be live (see § 2.4.3).

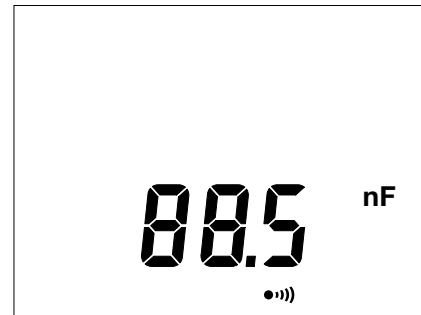

2.7. ΔREL FUNCTION (C.A 6524 AND C.A 6526)

For an insulation, resistance, or capacitance measurement, it is possible to subtract a reference value from the measured value and display the difference.

To do this, make a measurement, then press the ΔREL. The measurement (Rref) is stored and subtracted from the present measurement (Rmeas).

The main display changes to zero and the ΔREL symbol is displayed.

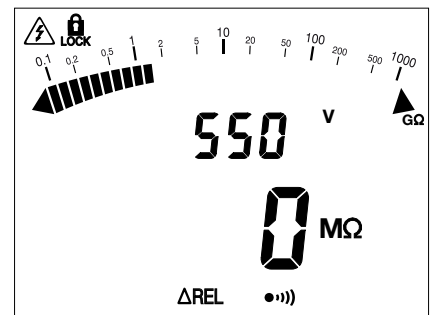

If the measured value is less than the stored value, the display becomes negative.



Pressing the ► key displays, in addition, the measured value as a % of the stored value.

$$\frac{R_{meas} - R_{ref}}{R_{ref}} \times 100$$

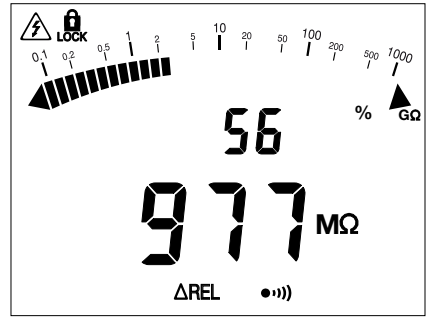

In insulation measurements, only the digital display is modified by the ΔREL. The bargraph continues to display the true measured value.

To exit from the ΔREL function, it is necessary to press the ΔREL key again or turn the switch.

2.8. HOLD FUNCTION



Pressing the **HOLD** key freezes the display of the measurement. This can be done in all functions except voltage in the **MΩ** setting.

To unfreeze the display, press the **HOLD** key again.

It is not possible to effect a **HOLD** in a timed measurement (⌚, DAR, PI).

2.9. BACKLIGHTING



Pressing the ☀ key switches on the backlighting of the display unit.

To switch it off, press the ☀ key again. Otherwise, it goes off by itself at the end of one minute.

2.10. SET-UP

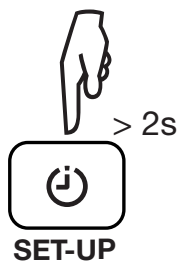

A long press on the SET-UP key is used to enter the configuration (set-up) function of the instrument.

Then use the ▲ and ► keys to scroll and modify the parameters.

1 st press on ▲		The buzzer is active. To deactivate it, press ► to make On blink, ▲ to change it to OFF , then ► to validate the change. The ●))) symbol disappears from the display when Set-up is exited.
2 nd press on ▲		Automatic switching off is activated. To deactivate it, press ► to make OFF blink, ▲ to change it to On , then ► to validate the change. The P symbol appears on the display when Set-up is exited.
3 rd press on ▲		Display of the type of instrument.
4 th press on ▲		Display of the internal software version.
5 th press on ▲		Display of the version of the boards.
6 th press on ▲		Return to the first press.

To exit from configuration, short-press the **SET-UP** key.

The de-activations of the buzzer and of automatic switching off are lost when the instrument is off.

2.11. ALARM FUNCTION

On the C.A 6522, in continuity testing, pressing the  symbol is displayed, along with the threshold, which is 2 Ohms. If the measurement is below this threshold and the buzzer is active, the instrument emits an audible signal.

On the C.A 6524 and the C.A 6526, pressing the  key activates the alarm. The alarm function is available in insulation, resistance, and continuity measurements.

The  symbol is displayed, along with the threshold, on the secondary display unit.

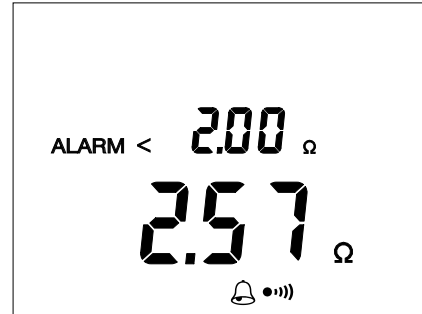
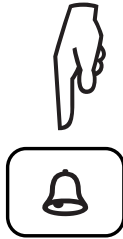



While it is displayed, you can change this value using the  key, except during insulation measurements. For each position of the switch, there are 3 pre-recorded threshold values:



- in continuity: < 2 Ω, < 1 Ω and < 0.5 Ω.
- in resistance: > 50kΩ, > 100kΩ and > 200kΩ.
- in insulation
 - 50V : < 50 kΩ, < 100 kΩ and < 200 kΩ.
 - 100V : < 100 kΩ, < 200 kΩ and < 400 kΩ.
 - 250V : < 250 kΩ, < 500 kΩ and < 1 MΩ.
 - 500V : < 500 kΩ, < 1 MΩ and < 2 MΩ.
 - 1000V : < 1 MΩ, < 2 MΩ and < 4 MΩ.



The third threshold can be replaced by a user-programmed value.

If you want a specific threshold value, press the  key to enter the programming function, while the threshold value is displayed.

The > symbol starts blinking; you can change it to < using the  key. This symbol indicates the direction of the alarm threshold: < for a low threshold and > for a high threshold.

Press the  key again to go to the first digit, then to the decimal point, then to the second digit, etc. down to the unit, and one final time on the  key to validate the programming of the threshold.

When the alarm threshold is crossed, i.e. when the measurement is below the low alarm threshold or above the high alarm threshold, the instrument emits a continuous audible signal and the secondary display unit displays the crossing of the threshold.

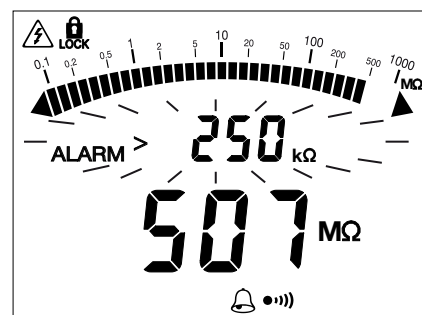
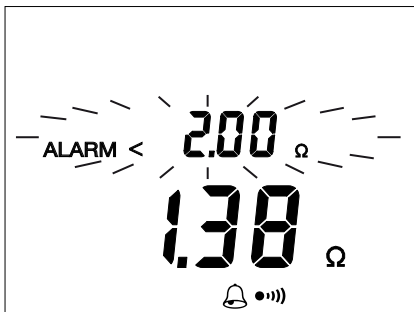

In the example above, the user can thus check that their continuity measurement is indeed less than 2 Ω, just by listening, without looking at the display unit. They can check insulation quality in the same way.

On the C.A 6526, the  key is green when the alarm threshold has not been crossed and red when it has. In continuity, it is the other way round. This enables the user to check the measurement at a glance.

The **HOLD** key is also used to stop the buzzer after an alarm threshold is crossed.

A second press on the  key deactivates the alarm.

2.12. AUTOMATIC STOP

After 5 minutes of operation with no sign of the user's presence (key press or rotation of the switch), the instrument switches to standby.

Simply press any key to exit from standby. The instrument returns to the state it was in, with no loss information: value of the last measurement, compensation of the leads, Δ Rel, timed mode, alarm, etc.

Automatic switching off is disabled during:

- insulation measurements in  mode and in timed mode (⌚, PI, or DAR).
- continuity measurements, for as long as measurements are made.

This automatic switching off can be disabled (see § 2.10).

2.13. STORAGE (C.A 6524 AND C.A 6526)

2.13.1. RECORDING A MEASUREMENT

To record a measurement, it is first necessary to freeze the display using the **HOLD** key or to wait for the end of a timed measurement. In insulation measurements, the measurement must be stable enough to be frozen.

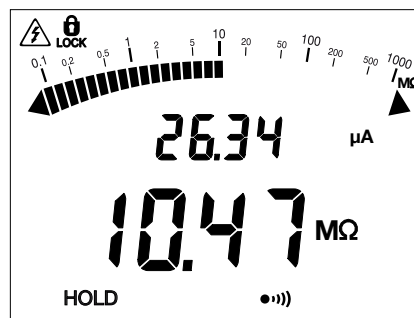

Then long-press the **MEM** key to store the measurement.

The measurement is recorded in the first memory slot available (here, number 1).

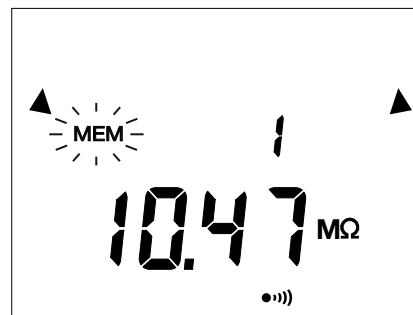
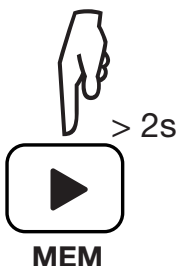

It is recorded with all information tied to it but not necessarily displayed at the time of storage: voltage, current, duration of tests T1 and T2 in the case of PI and DAR, etc.

The bargraph indicates the level of filling of the memory.

2.13.2. REREADING THE RECORDS

Set the switch to **MR**.

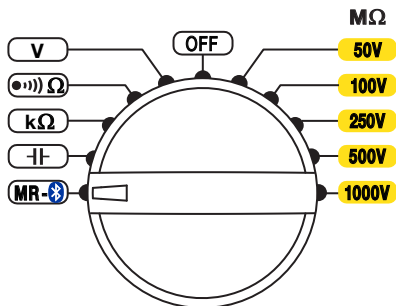

The instrument displays the last measurement recorded.

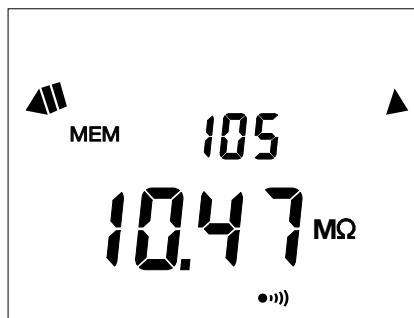

To see the other measurements, press the ▲ key. The record number is decremented and the corresponding measurement is displayed.
To scroll rapidly through the recorded measurements, keep the ▲ key pressed.

To see one particular measurement, use the ► key to change the record number.

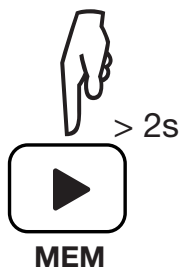

Once the record number has been chosen, you can see all information concerning the measurement. Long-press the **MEM** key, then use the ▲ key to scroll the information.

To exit from this rereading of records, long-press **MEM** again.

2.13.3. ERASING ONE RECORD

Set the switch to **MR**.

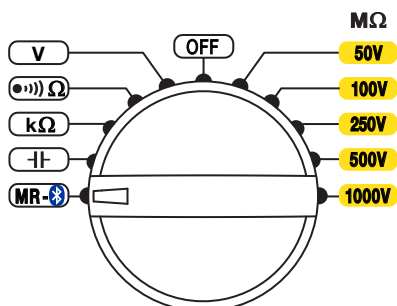

Use the ▲ and ►, keys to select the number of the record to be erased.
Then long-press the **CLR** key.

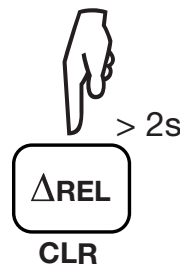

The record number blinks and the main display unit displays **CLR**.

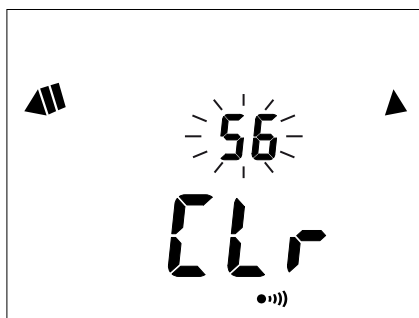

Then long-press the **MEM** key to confirm the erasure.

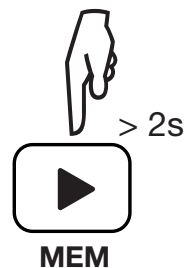

Otherwise, to cancel, long press the **CLR** key again.

2.13.4. ERASING ALL RECORDS

Repeat the record erasure procedure:

- Set the switch to **MR**.
- Long-press the **CLR** key.
- Press the **▲** key and the record number is replaced by **ALL**.
- To cancel, long-press the **CLR** key again.
- Otherwise, to confirm the erasure of all records, long-press the **MEM** key.

The instrument then reports that the memory is empty.



2.14. BLUETOOTH COMMUNICATION (C.A 6526)

Before connecting your instrument for the first time, install the MEG software delivered with it.



Set the switch to **MR** .

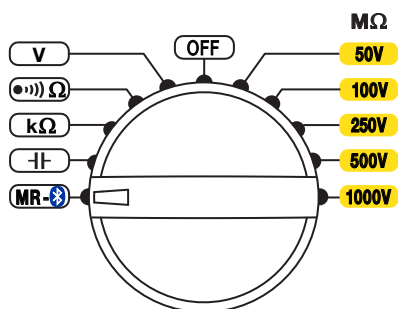

Then long-press the  key.

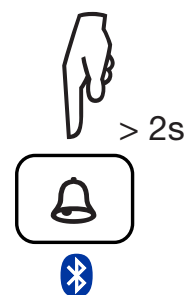

The  symbol is displayed and the instrument waits for a message from the computer. When the link is set up, the  symbol starts blinking.

If your PC does not have a Bluetooth port, install a USB-Bluetooth adapter. Then, in the Windows bar, locate the Bluetooth logo, right-click on it, and choose **Add a peripheral**.

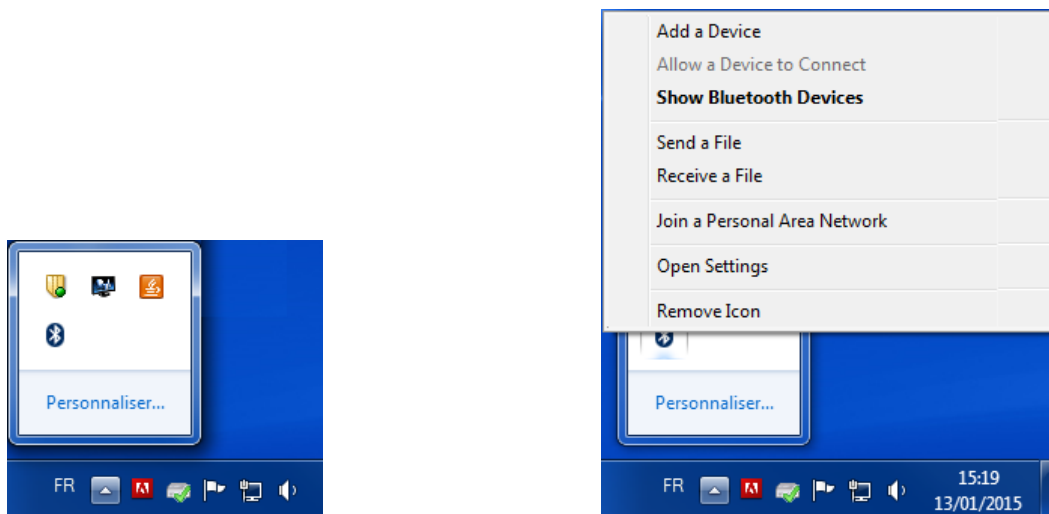

The PC searches its environment for Bluetooth-compatible devices. When the megohmmeter is detected, select it and click **Next**.

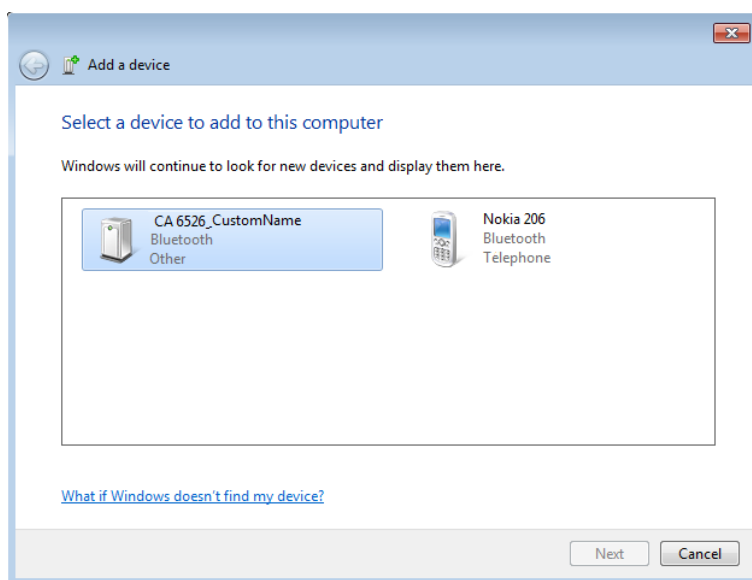

If a coupling code is requested, enter 1111.

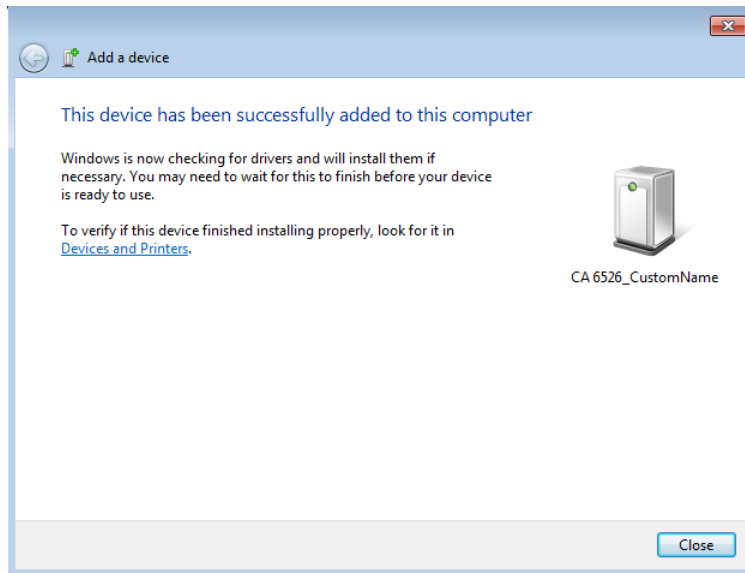

You can then transfer recorded data from the instrument to the computer. If you turn the switch to an insulation position, you can transmit the measurements in real time.

To use the MEG software, refer to its help function.

To exit from the Bluetooth connection, long-press the  key again, whatever the setting of the switch.

2.15. ERRORS

While the instrument is in operation, errors may be reported. The causes of any errors must be eliminated before the instrument can be used again.

2.15.1. PRESENCE OF A VOLTAGE BEFORE AN INSULATION MEASUREMENT

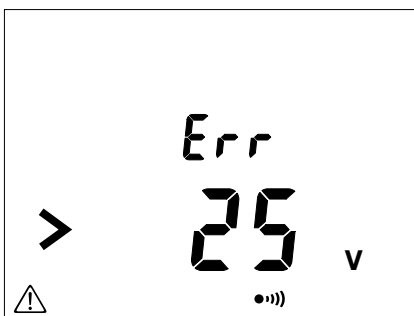

Before the insulation measurement, the instrument is in voltage measurement mode. If there is a voltage on the terminals in excess of 25 V and you try even so to make a measurement, the instrument reports the situation.

Eliminate the voltage and resume the measurement.

2.15.2. OVERSHOOT OF RANGE DURING AN INSULATION MEASUREMENT



If, during an insulation measurement, the value to be measured exceeds the measurement range (which depends on the instrument and the test voltage), the instrument so reports.

In the case of a C.A 6524 or C.A 6526 in the 1000 V range, that leads to display of the screen shown opposite.

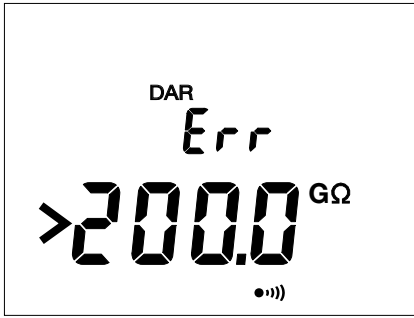

With the C.A 6524 or C.A 6526, if this occurs during a DAR or PI measurement, the instrument interrupts the measurement and displays the screen shown opposite.

2.15.3. PRESENCE OF A VOLTAGE DURING A CONTINUITY, RESISTANCE, OR CAPACITANCE MEASUREMENT

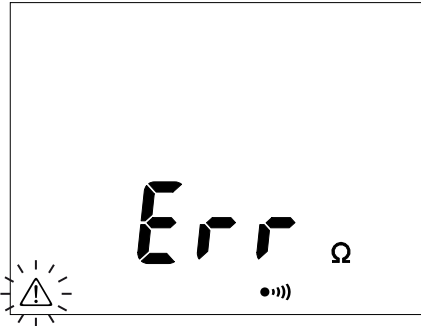

If, during a continuity, resistance, or capacitance measurement, the instrument detects an external voltage in excess of 15 V (AC or DC), it interrupts the measurement and displays the screen shown opposite.

You must eliminate the voltage to be able to resume the measurement.

2.15.4. MEMORY FULL (C.A 6524 AND C.A 6526)

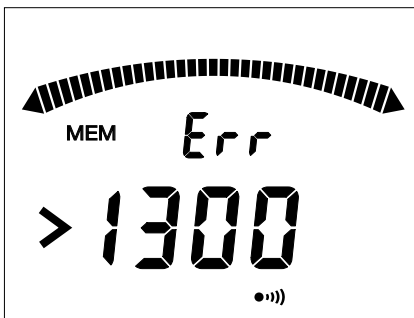

When the memory is full (300 records for the C.A 6524; 1300 for the C.A 6526), it is no longer possible to record measurements and the instrument displays the screen shown opposite.

Records must then be erased before new measurements can be recorded.

2.16. RESETTING THE INSTRUMENT

If your instrument crashes, it can be reset like a PC.

Press the ▲ and ✖ keys simultaneously.



The instrument reboots.

Then turn the switch.

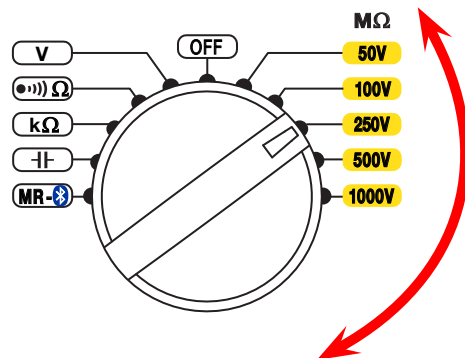

3. TECHNICAL CHARACTERISTICS

3.1. GENERAL REFERENCE CONDITIONS

Quantity of influence	Reference values
Temperature	23 ± 3 °C
Relative humidity	45 to 55% RH
Frequency	DC and 45 to 65 Hz
Supply voltage	8 ± 0.2V battery life indication 58 ± 8%
Electric field	0V/m
Magnetic field	< 40A/m

The **intrinsic uncertainty** is the error specified for the reference conditions.

The **operating uncertainty** includes the intrinsic uncertainty plus variations of the quantities of influence (position, supply voltage, temperature, etc.) as defined in standard IEC-61557.

The uncertainties are expressed in % of the reading (R) and in number of display points (ct):
± (a %R + b ct)

3.2. ELECTRICAL CHARACTERISTICS

3.2.1. VOLTAGE MEASUREMENTS

Particular reference conditions

Peak factor = 1.414 in AC, sinusoidal signal

Specified measurement range	0.3 - 399.9V	400 - 700V
Resolution	0.1V	1V
Intrinsic uncertainty	± (3% + 2 ct)	
Input impedance	400kΩ	
Frequency ranges	DC and 15.3 at 800Hz	

3.2.2. FREQUENCY MEASUREMENTS

Measurement range	15.3 - 399.9Hz	400 - 800Hz
Resolution	0.1Hz	1Hz
Intrinsic uncertainty	± (1% + 2 ct)	± (1.5% + 1 ct)

3.2.3. INSULATION MEASUREMENT

Particular reference conditions

Capacitance in parallel on resistance: null

Measurement ranges as a function of the model of instrument

Test voltage	C.A 6522	C.A 6524	C.A 6526
50V		10kΩ - 10GΩ	10kΩ - 10GΩ
100V		20kΩ - 20GΩ	20kΩ - 20GΩ
250V	50kΩ - 10GΩ	50kΩ - 50GΩ	50kΩ - 50GΩ
500V	100kΩ - 20GΩ	100kΩ - 100GΩ	100kΩ - 100GΩ
1,000V	200kΩ - 40GΩ	200kΩ - 200GΩ	200kΩ - 200GΩ

Intrinsic uncertainty

Test voltage (U_N)	50V - 100V - 250V - 500V - 1,000V					
Specified measurement range	10 - 999 k Ω and 1.000 - 3.999 M Ω	4.00 - 39.99 M Ω	40.0 - 399.9 M Ω	400 - 3999 M Ω	4.00 - 39.99 G Ω	40.0 - 200.0 G Ω
Resolution	1k Ω	10k Ω	100k Ω	1M Ω	10M Ω	100M Ω
Intrinsic uncertainty	<ul style="list-style-type: none"> ■ For $U_N = 50V: \pm (3\% + 2 \text{ ct} + 2\%/G\Omega)$ ■ For $U_N = 100V: \pm (3\% + 2 \text{ ct} + 1\%/G\Omega)$ ■ For $U_N = 250V: \pm (3\% + 2 \text{ ct} + 0.4\%/G\Omega)$ ■ For $U_N = 500V: \pm (3\% + 2 \text{ ct} + 0.2\%/G\Omega)$ ■ For $U_N = 1,000V: \pm (3\% + 2 \text{ ct} + 0.1\%/G\Omega)$ 					

Whatever the test voltage, for an insulation resistance $\leq 2 \text{ G}\Omega$, the intrinsic uncertainty is $\pm (3\% + 2 \text{ ct})$.

Bargraph

Specified measurement range	0.1M Ω - 200G Ω *
Resolution	9 segments per decade
Intrinsic uncertainty	$\pm (5\% + 1 \text{ segment})$

*: When the measurement range is exceeded, the whole bargraph is displayed.

Test voltage

With a test current $< 1 \text{ mA}$, the intrinsic uncertainty on U_N is $-0\% + 20\%$.

Specified measurement range	0.0 - 399.9V	400 - 1,250V
Resolution	0.1V	1V
Intrinsic uncertainty	$\pm (3\% + 3 \text{ ct})$	

Typical discharge time after test

To go from U_N to 25 V, the discharge time is $< 2s/\mu F$

Test current

Maximum test current: 2mA $+0\%$ -50%

Specified measurement range	0.01 - 39.99 μA	40.0 - 399.9 μA	0.400 - 2.000mA
Resolution	10nA	100nA	1 μA
Intrinsic uncertainty	$\pm (10\% + 3 \text{ ct})$		

Typical test voltage vs load curve

The voltage as a function of the measured resistance takes the following form:

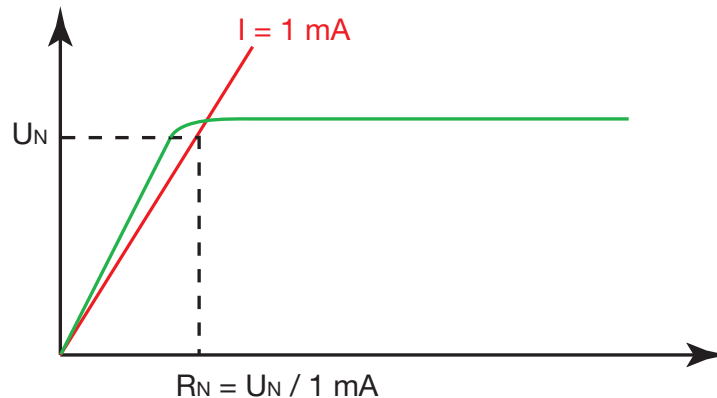

The range of operation per IEC 61557 is from 100kΩ to 2 GΩ (see § 3.4).

3.2.4. CONTINUITY MEASUREMENTS

Particular reference conditions

Inductance in series with the resistance: zero.

Specified measurement range (without compensation of the leads)	0.00 * - 10.00 Ω	0.0 * - 100.0 Ω
Resolution	10mΩ	100mΩ
Intrinsic uncertainty	± (2% + 2 ct)	
Test current	200mA	20mA
No-load voltage	≥ 6V	

*: In the case of incorrect compensation of the leads, the instrument allows display of negative values, down to -0.05 Ω at 200 A and -0.5 Ω at 20 mA.

Test current

200 mA range: 200mA (-0mA + 20mA)

20 mA range: 20mA ± 5mA

Specified measurement range	0 - 250mA
Resolution	1mA
Intrinsic uncertainty	± (2 % + 2 ct)

Compensation of the leads: 0 to 9.99 Ω.

3.2.5. RESISTANCE MEASUREMENTS (C.A 6524 AND C.A 6526)

Specified measurement range	0 - 3999 Ω	4.00 - 39.99kΩ	40.0 - 399.9kΩ	400 - 1000kΩ
Resolution	1Ω	10Ω	100Ω	1kΩ
Intrinsic uncertainty	± (3% + 2 ct)			
No-load voltage	approximately 4.5V			

3.2.6. CAPACITANCE MEASUREMENTS (C.A 6526)

Specified measurement range	0.1 - 399.9nF	400 - 3999nF	4.00 - 10.0μF
Resolution	0.1nF	1nF	10nF
Intrinsic uncertainty	± (3% + 2 ct)		

3.2.7. TIMER

Specified measurement range	0:00 - 39:59
Resolution	1s
Intrinsic uncertainty	± 1s

3.2.8. STORAGE

Number of records:

- 300 for the C.A 6524
- 1300 for the C.A 6526.

3.2.9. BLUETOOTH

Bluetooth 2.1

Class II

Range 10 metres

3.3. VARIATION IN THE RANGE OF USE

3.3.1. VOLTAGE MEASUREMENT

Quantities of influence	Range of influence	Quantity influenced	Influence	
			Typical	Maximum
Temperature	-20 to + 55 °C	V, F		0.3%/10 °C + 1 ct
Relative humidity	20 to 80% RH	V, F		1% + 2 ct
Frequency	15.3 to 800Hz	V	1%	2% + 1 ct
Supply voltage	6.6 to 9.6V	V, F		0.1% + 2 ct
Common mode rejection in AC 50/60 Hz	0 to 600V _{AC}	V	50dB	40dB

3.3.2. INSULATION MEASUREMENT

Quantities of influence	Range of influence	Quantity influenced	Influence	
			Typical	Maximum
Temperature	-20 to + 55 °C	MΩ R ≤ 3GΩ 3GΩ < R < 10GΩ 10GΩ ≤ R	1%/10°C + 1pt	2%/10 °C + 2 ct 3%/10 °C + 2 ct 4%/10 °C + 2 ct
		U _N : 50 to 500V U _N : 1,000V		0.5%/10 °C + 1 ct 1%/10 °C + 1 ct
		Measurement current	1%/10 °C + 1 ct	2%/10 °C + 2 ct
Relative humidity	20 to 80% RH	MΩ	2% + 1 ct	3% + 2 ct
		U _N : 50 to 1,000V		1% + 2 ct
		Measurement current		1% + 2 ct
Supply voltage	6.6 to 9.6V	MΩ		0.1% + 2 ct
50/60Hz AC voltage superposed on the test voltage (U _N)		50V range R ≤ 0.1GΩ : 4V from 0.1GΩ to 1GΩ : 0.2V		5% + 2 ct
		100V and 250V ranges from 100kΩ to 10MΩ : 20V from 10MΩ to 1 GΩ : 0.3V		
		500V and 1,000V ranges from 500kΩ to 50MΩ : 20V from 50MΩ to 3 GΩ : 0.3V		

Quantities of influence	Range of influence	Quantity influenced	Influence	
			Typical	Maximum
Capacitance in parallel on resistance to be measured	0 to 5 μ F at 1mA	M Ω		1% + 1 ct
	0 to 2 μ F	50V, 100V and 250V ranges from 10k Ω to 3 G Ω	6% + 2 ct	10% + 2 ct
		500V and 1,000V ranges from 100k Ω to 10G Ω	6% + 2 ct	10% + 2 ct
	0 to 1 μ F	50V range, \leq 5G Ω 250V range, \leq 15G Ω 1,000V range, \leq 100G Ω	6% + 2 ct	10% + 2 ct
Common mode rejection in AC 50/60 Hz	0 to 600V _{AC}	V	50dB	40dB

3.3.3. RESISTANCE AND CONTINUITY MEASUREMENT

Quantities of influence	Range of influence	Quantity influenced	Influence	
			Typical	Maximum
Temperature	-20 to + 55 °C	at 200mA		2%/10 °C + 2 ct
		at 20mA		2%/10 °C + 2 ct
		R		1%/10 °C + 2 ct
Relative humidity	20 to 80% RH	at 200mA		4% + 2 ct
		at 20mA		4% + 2 ct
		R		3% + 2 ct
Supply voltage	6.6 to 9.6V	at 200mA at 20mA R		0.1% + 2 ct
50/60Hz AC voltage superposed on the test voltage	0.5V _{AC}	at 200mA		5% + 10 ct
	For R \geq 10 Ω : 0.4V _{AC}	at 20mA		
	Accepts no perturbations	R		
Common mode rejection in AC 50/60 Hz	0 to 600V _{AC}	at 200mA at 20mA R	50dB	40dB

3.3.4. CAPACITANCE MEASUREMENT (C.A6526)

Quantities of influence	Range of influence	Quantity influenced	Influence	
			Typical	Maximum
Temperature	-20 to + 55 °C	μ F	0.5%/10 °C + 1 ct	1%/10 °C + 2 ct
Relative humidity	20 to 80% RH	μ F		1% + 2 ct
Supply voltage	6.6 to 9.6V	μ F		0.1% + 2 ct
50/60Hz AC voltage superposed on the test voltage	0.5V _{AC}	μ F		5% + 2 ct
Common mode rejection in AC 50/60 Hz	0 to 600V _{AC}	μ F	50dB	40dB

3.4. INTRINSIC UNCERTAINTY AND OPERATING UNCERTAINTY

The megohmmeters comply with standard IEC-61557, which requires that the operating uncertainty, called B, be less than 30%.

- In insulation measurements, $B = \pm (|A| + 1.15 \sqrt{E_1^2 + E_2^2 + E_3^2})$
with A = intrinsic uncertainty
E₁ = influence of the reference position ± 90°.
E₂ = influence of the supply voltage within the limits indicated by the manufacturer.
E₃ = influence of the temperature between 0 and 35°C.

- In continuity measurement, $B = \pm (|A| + 1.15 \sqrt{E_1^2 + E_2^2 + E_3^2})$

3.5. POWER SUPPLY

The instrument is powered by six 1.5 V alkaline AA (LR6) batteries.
The voltage range ensuring correct operation is from 6.6 V to 9.6 V.

Life between charges

- 1,500 5-second insulation measurements at 1000V for R = 1 MΩ, at the rate of one measurement per minute.
- 3,000 5-second continuity measurements, at the rate of one measurement per minute.

3.6. ENVIRONMENTAL CONDITIONS

Indoor use.

Range of operation specified	-20 to +55 °C and 20 to 80 %RH
Range of storage (without the batteries)	-30 to +80 °C and 10 to 90 %RH without condensation
Altitude	<2000m
Degree of pollution	2

3.7. MECHANICAL CHARACTERISTICS

Dimensions (L x W x H)	211 x 108 x 60mm
Weight	approximately 850g

Inrush protection	IP 54 per IEC 60529, not in operation IK 04 per IEC 50102
-------------------	--

Drop test	per IEC 61010-1
-----------	-----------------

3.8. COMPLIANCE WITH INTERNATIONAL STANDARDS

The device is compliant per IEC 61010-1 and IEC 61010-2-030, 600V CAT IV.

The device is compliant per EC 61557, parts 1, 2, 4 and 10.

3.9. ELECTROMAGNETIC COMPATIBILITY (CEM)

The instrument is compliant with standard IEC 61326-1.

4. MAINTENANCE



Except for the batteries, the instrument contains no parts that can be replaced by personnel who have not been specially trained and accredited. Any unauthorized repair or replacement of a part by an “equivalent” may gravely impair safety

4.1. CLEANING

Disconnect the unit completely and turn the rotary switch to OFF.

Use a soft cloth, dampened with soapy water. Rinse with a damp cloth and dry rapidly with a dry cloth or forced air. Do not use alcohol, solvents, or hydrocarbons.

Do not use the instrument again until it is completely dry.

4.2. REPLACING THE BATTERIES

When the  symbol starts blinking on the display unit, the batteries must all be replaced.

- Disconnect the unit completely and turn the rotary switch to OFF.
- Use a tool or a coin to turn the quarter-turn screw of the battery compartment cover.
- Remove the battery compartment cover.
- Withdraw the batteries from the compartment.

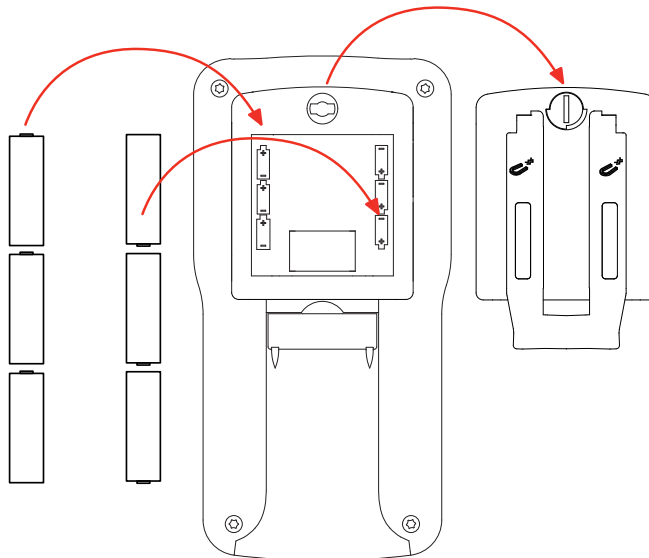

Spent primary and storage batteries must not be treated as ordinary household waste. Take them to the appropriate collection point for recycling.

- Place the new batteries in the compartment, taking care with the polarity.
- Put the battery compartment cover in place and screw the quarter-turn screw back in.

5. WARRANTY

Except as otherwise stated, our warranty is valid for **24 months** starting from the date on which the equipment was sold. Extract from our General Conditions of Sale provided on request.

The warranty does not apply in the following cases:

- Inappropriate use of the equipment or use with incompatible equipment;
- Modifications made to the equipment without the explicit permission of the manufacturer's technical staff;
- Work done on the device by a person not approved by the manufacturer;
- Adaptation to a particular application not anticipated in the definition of the equipment or not indicated in the user's manual;
- Damage caused by shocks, falls, or floods.

FRANCE

Chauvin Arnoux Group

190, rue Championnet

75876 PARIS Cedex 18

Tél : +33 1 44 85 44 85

Fax : +33 1 46 27 73 89

info@chauvin-arnoux.com

www.chauvin-arnoux.com

INTERNATIONAL

Chauvin Arnoux Group

Tél : +33 1 44 85 44 38

Fax : +33 1 46 27 95 69

Our international contacts

www.chauvin-arnoux.com/contacts

