

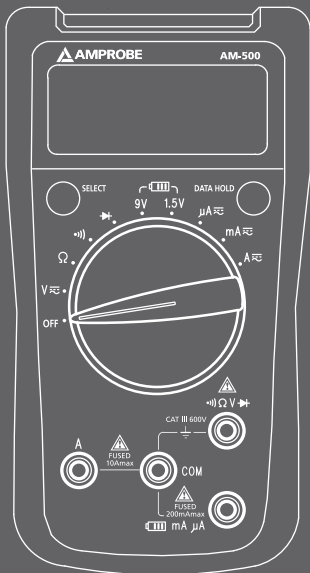

HARD AT WORK SINCE 1948.



AM-500
Autoranging
Multimeter

AM-500-EUR
Digital
Multimeter

Users Manual



AM-500

Autoranging Multimeter

AM-500-EUR

Digital Multimeter

Users Manual

English

Limited Warranty and Limitation of Liability

Your Amprobe product will be free from defects in material and workmanship for one year from the date of purchase, unless local laws require otherwise. This warranty does not cover fuses, disposable batteries or damage from accident, neglect, misuse, alteration, contamination, or abnormal conditions of operation or handling. Resellers are not authorized to extend any other warranty on Amprobe's behalf. To obtain service during the warranty period, return the product with proof of purchase to an authorized Amprobe Service Center or to an Amprobe dealer or distributor. See Repair Section for details. THIS WARRANTY IS YOUR ONLY REMEDY. ALL OTHER WARRANTIES - WHETHER EXPRESS, IMPLIED OR STATUTORY - INCLUDING IMPLIED WARRANTIES OF FITNESS FOR A PARTICULAR PURPOSE OR MERCHANTABILITY, ARE HEREBY DISCLAIMED. MANUFACTURER SHALL NOT BE LIABLE FOR ANY SPECIAL, INDIRECT, INCIDENTAL OR CONSEQUENTIAL DAMAGES OR LOSSES, ARISING FROM ANY CAUSE OR THEORY. Since some states or countries do not allow the exclusion or limitation of an implied warranty or of incidental or consequential damages, this limitation of liability may not apply to you.

Repair

All test tools returned for warranty or non-warranty repair or for calibration should be accompanied by the following: your name, company's name, address, telephone number, and proof of purchase. Additionally, please include a brief description of the problem or the service requested and include the test leads with the meter. Non-warranty repair or replacement charges should be remitted in the form of a check, a money order, credit card with expiration date, or a purchase order made payable to Amprobe®.

In-Warranty Repairs and Replacement – All Countries

Please read the warranty statement and check your battery before requesting repair. During the warranty period any defective test tool can be returned to your Amprobe® distributor for an exchange for the same or like product. Please check the "Where to Buy" section on www.amprobe.com for a list of distributors near you. Additionally, in the United States and Canada In-Warranty repair and replacement units can also be sent to a Amprobe® Service Center (see address below).

Non-Warranty Repairs and Replacement – US and Canada

Non-warranty repairs in the United States and Canada should be sent to an Amprobe® Service Center. Call Amprobe® or inquire at your point of purchase for current repair and replacement rates.

In USA:

Amprobe

Everett, WA 98203

Tel: 877-AMPROBE (267-7623)

In Canada:

Amprobe

Mississauga, ON L4Z 1X9

Tel: 905-890-7600

Non-Warranty Repairs and Replacement – Europe

European non-warranty units can be replaced by your Amprobe® distributor for a nominal charge. Please check the "Where to Buy" section on www.amprobe.com for a list of distributors near you.

European Correspondence Address*

Amprobe® Europe

Beha-Amprobe GmbH

In den Engematten 14

79286 Glottertal, Germany

Tel.: +49 (0) 7684 8009 - 0

www.beha-amprobe.com

*(Correspondence only – no repair or replacement available from this address. European customers please contact your distributor.)

AM-500 Autoranging Multimeter

AM-500-EUR DIY-PRO Digital Multimeter

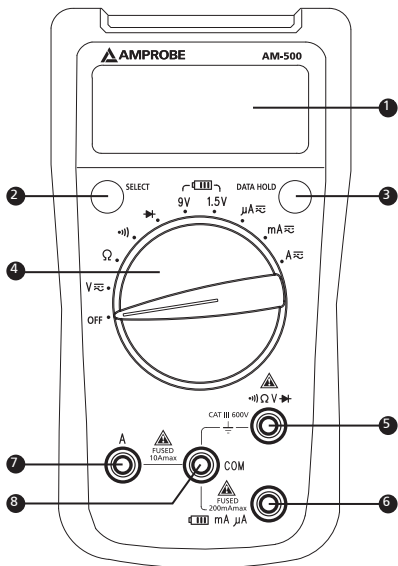

- 1 LCD Display
- 2 SELECT Button
- 3 DATA HOLD Button
- 4 Rotary Switch
- 5 Input Terminal for voltage, diode, resistance and continuity measurement
- 6 Input Terminal for battery test and AC/DC mA or μA measurement
- 7 Input Terminal for AC/DC A measurement to 10A
- 8 COM (return) terminal for all measurements

Screen Display

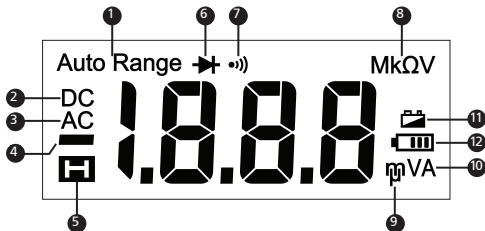













- 1 The Meter selects the range with best resolution
- 2 Direct Current
- 3 Alternate Current
- 4 Negative reading
- 5 Data hold
- 6 Diode test
- 7 Continuity test
- 8 Measurement units for resistance test
- 9 Measurement units for voltage test
- 10 Measurement units for current test
- 11 Low battery indicator
- 12 Battery Test

CONTENTS

SYMBOLS	2
SAFETY INFORMATION	2
UNPACKING AND INSPECTION	4
FEATURES	4
MAKING MEASUREMENT	5
Rotary Switch Positions.....	5
SELECT Button	6
DATA HOLD Button.....	6
Auto Power OFF	6
Measuring AC and DC Voltage.....	6
Measuring Resistance	7
Measuring Continuity	7
Measuring Diode.....	8
Battery Test.....	8
Measuring AC and DC Current.....	9
SPECIFICATION	10
MAINTENANCE AND REPAIR	14
BATTERY AND FUSE REPLACEMENT	15

SYMBOLS

	Caution ! Risk of electric shock.
	Caution! Refer to the explanation in this Manual
	Alternating Current (AC)
	Direct Current (DC)
	The equipment is protected by double insulation or reinforced insulation
	Earth (Ground)
	Audible tone
	Battery
	Complies with European Directives
	Conforms to relevant Australian standards
	Canadian Standards Association (NRTL/C)
	Do not dispose of this product as unsorted municipal waste. Contact a qualified recycler.

SAFETY INFORMATION

The Meter complies with:

IEC/EN 61010-1 3rd Edition, UL61010-1 2nd Ed. and CAN/CSA-C22.2 No. 61010-1-04 + CSA Update No.1: 2008 to Category III 600 Volts, Pollution degree 2

IEC/EN 61010-2-030

IEC/EN 61010-2-31 for test leads

EMC IEC/EN 61326-1

“This product has been tested to the requirements of CAN/CSA-C22.2 No. 61010-1, second edition, including Amendment 1, or a later version of the same standard incorporating the same level of testing requirements”.

Measurement Category III (CAT III) is for measurements performed in the building installation. Examples are measurements on distribution boards, circuit- breakers, wiring, including cables, bus-bars, junction boxes,

switches, socket-outlets in the fixed installation, and equipment for industrial use and some other equipment, for example, stationary motors with permanent connection to the fixed installation.

CENELEC Directives

The instruments conform to CENELEC Low-voltage directive 2006/95/EC and Electromagnetic compatibility directive 2004/108/EC

Warning: Read Before Using

- *To avoid possible electrical shock or personal injury, follow these instructions and use the Meter only as specified in this manual.*
- *Do not use the Meter or test leads if they appear damaged, or if the Meter is not operating properly. If in doubt, have the Meter serviced.*
- *Always use the proper function and range for measurements.*
- *Before rotating the function range selection switch, disconnect test probe from circuit under test.*
- *Verify the Meter's operation by measuring on a known voltage source.*
- *Do not apply more than the rated voltage, as marked on the Meter, between the test probe or between any test probe and earth ground.*
- *Use the Meter with caution for voltages above 30 Vac rms, 42 Vac peak, or 60 Vdc. These voltages pose electrical shock hazards.*
- *Disconnect circuit power and discharge all high-voltage capacitors before testing resistance.*
- *Do not use the Meter around explosive gas or vapor.*
- *When using the test leads, keep your fingers behind the finger guards.*
- *Remove test leads from the Meter before opening the Meter case or battery door.*
- *if the meter is used in a manner not specified in the users manual, the protection provided by the equipment may be impaired*

UNPACKING AND INSPECTION

Your shipping carton should include:

- 1 AM-500 or AM-500-EUR Multimeter
- 1 Pair of test leads
- 2 1.5V alkaline AAA battery (installed)
- 1 Users manual
- 1 Carrying case

If any of the items are damaged or missing, return the complete package to the place of purchase for an exchange.

FEATURES

Easy to use digital multimeter designed for the homeowner or DIY enthusiast. Install, troubleshoot or repair light fixtures, fans, appliances, or automotive electrical problems with easy and safety of a CAT III 600V rated product. Check for voltage in electrical sockets, extension cords, batteries and other electrical circuits. Let the power of a professional Amprobe multimeter keep you safe and help you solve all your electrical challenges.

- Measurements: Voltage up to 600V AC/DC, AC/DC Current and Resistance
- Audible continuity
- Diode Test
- Data hold
- Auto power off
- Low battery warning
- Safety: CAT III 600V

MAKING MEASUREMENT



1. Use the proper function and range for measurements.
2. To avoid possible electrical shock, personal injury or damages to the Meter, disconnect circuit power and discharge all high-voltage capacitors before testing resistance and diode.
3. Connecting test leads:
 - Connect the common (COM) test lead to the circuit before connecting the live lead.
 - After measurement, remove live lead before removing the common (COM) test lead from the circuit.
4. Symbol "OL" is displayed on LCD when the measurement is out of range.

Rotary Switch Positions

Switch Position		Measurement Function
V		AC or DC voltage measurement (use SELECT button for switching to AC or DC).
Ω		Resistance measurement
		Voltage measurement of diode PN junction
		Continuity measurement
	9V	For measurement of dry batteries of not exceeding 15Vdc
	1.5V	For measurement of dry batteries of not exceeding 2Vdc
μA mA A		AC or DC current measurement (use SELECT button for switching to AC or DC).

Button	SELECT	Press to select alternate measurement functions on the rotary switch.
	DATA HOLD	Display freezes present reading

SELECT Button

Press the yellow SELECT button to select alternate measurement functions on the rotary switch.

DATA HOLD Button

Press DATA HOLD button to freeze present reading on display. Press again to resume normal operation.

Auto Power OFF

Auto power off: approx. 15 minutes.

When the Meter is in auto power off mode, press SELECT or DATA HOLD button to resume normal operation.

Measuring AC and DC Voltage

Press SELECT button to switch to DC voltage measurement function.

⚠ ⚠ Do not apply on a voltage source higher than AC/DC 600V.

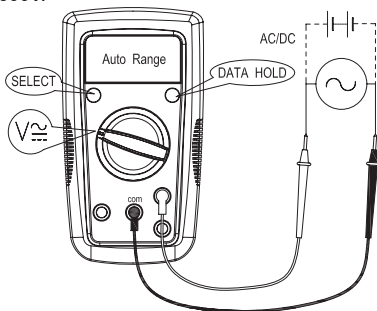

Measuring Resistance

⚠ ⚠ Disconnect circuit power and discharge all high-voltage capacitors before testing resistance.

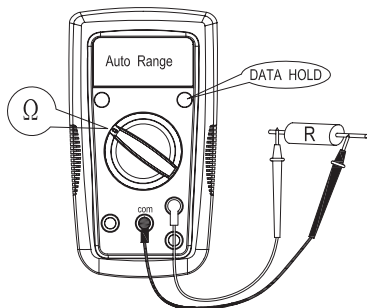

Note: On a higher resistance measurement ($>1\text{M}\Omega$), the measurement may take a few seconds to get stable reading.

Measuring Continuity

⚠ ⚠ Disconnect circuit power and discharge all high-voltage capacitors before testing continuity.

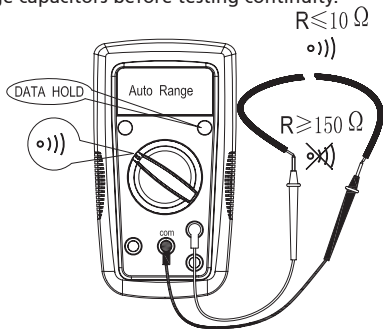

Measuring Diode

⚠ ⚠ Disconnect circuit power and discharge all high-voltage capacitors before testing diode.

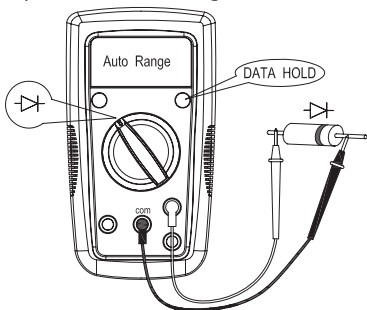

Battery Test

⚠ ⚠ Applying a voltage source or incorrect battery type under battery test may cause personal injury or damage to the Meter.

Battery 1.5V range is for dry battery not exceeding 2Vdc. The resistance load is around 30Ω.

Battery 9V range is for dry battery not exceeding 15Vdc. The resistance load is around 1KΩ. The resistance load is around 1KΩ.

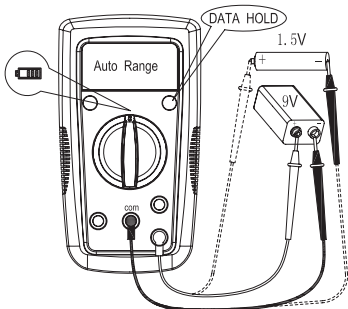

Measuring AC and DC Current

Press SELECT button for switching to DC current measurement function.

⚠ ⚠ To avoid personal injury or damage to the Meter:

1. Do not attempt to make an in-circuit current measurement when the open-circuit potential to earth ground exceeding 600 V.
2. Switch to proper function and range for your measurement.
3. Do not place the test probe in parallel with a circuit when the test leads are connected to the current terminals.
4. Connect the test leads to the correct input A/mA μ A current terminal and to the circuit before powering the circuit under test.
5. After measurement, switching OFF the circuit's power before removing test leads from the circuit.

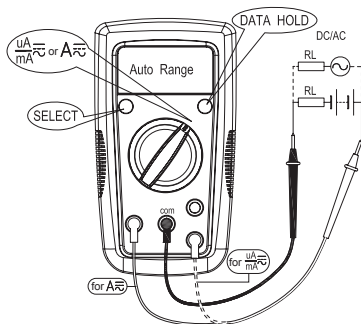

For current range from 8-10A, do not measure current for more than one (1) minute. Wait for 10 minutes before taking another measurement.

SPECIFICATION

Ambient temperature: 23°C ±5°C (73.4°F ±9°F)

Relative temperature: ≤ 75%

Accuracy: ±(% of reading + digits)

Maximum voltage between input terminal and earth ground: AC 600Vrms or DC 600V

⚠ Fuse for mA μA input:

0.5A H 660V fast-fuse, Φ6.3x32mm (AM-500)

0.5A H 700V fast-fuse, Φ6.3x32mm (AM-500-EUR)

⚠ Fuse for 10A input:

10A H 660V fast-fuse, Φ6.3x32mm (AM-500)

10A H 600V fast-fuse, Φ6x25mm (AM-500-EUR)

Maximum display: 1999, updates 2 to 3/sec

Over-range indication: OL

Range: Automatic

Altitude: Operating ≤ 2000m

Operating temperature: 0°C ~ +40°C (32°F ~ 104°F)

Relative humidity: 0°C ~ +30°C (32°F ~ 86°F) ≤ 75%; +30°C ~ +40°C (86°F ~ 104°F) ≤ 50%

Storage temperature: -10°C ~ +50°C (14°F ~ 122°F)

Electromagnetic compatibility: In an RF field of 1V/m = Specified accuracy ±5%

Battery: 2 x 1.5V AAA alkaline battery or equivalent

Low battery indication: 

Dimensions (L x W x H): 150 mm x 83 mm x 40 mm (5.9 in x 3.3 in x 1.6 in)

Weight: Approx. 290g (0.64lb) with batteries installed

1. DC Voltage Measurement

Range	Resolution	Accuracy
200.0mV	0.1mV	$\pm(0.8\%+3\text{dgt})$
2.000V	1mV	$\pm(0.8\%+1\text{dgt})$
20.00V	10mV	
200.0V	100mV	
600V	1V	$\pm(1.0\%+3\text{dgt})$

Input impedance: around 10M Ω ; (Input impedance > 3G Ω for DC 200mV range)

Overload protection: 600VDC or AC rms

2. AC Voltage Measurement

Range	Resolution	Accuracy
2.000V	1mV	$\pm(1.0\%+3\text{dgt})$
20.00V	10mV	
200.0V	100mV	
600V	1V	$\pm(1.2\%+3\text{dgt})$

Input impedance: around 10M Ω

Frequency response: 45Hz ~ 400Hz



Overload protection: 600VDC or AC rms

3. Resistance Measurement

Range	Resolution	Accuracy
200.0 Ω	0.1 Ω	$\pm(1.2\%+5\text{dgt})$ at $\leq 5\Omega$ $\pm(1.2\%+3\text{dgt})$ at $> 5\Omega$
2.000k Ω	1 Ω	$\pm(1.0\%+2\text{dgt})$
20.00k Ω	10 Ω	
200.0k Ω	100 Ω	
2.000M Ω	1k Ω	$\pm(1.2\%+2\text{dgt})$
20.00M Ω	10k Ω	$\pm(1.5\%+5\text{dgt})$

200Ω range: Measured value = (Measured display value) – (Short-circuiting value of probe)
Open circuit voltage: around 0.5V
Overload protection: 600V

4. : Continuity : Diode measurement

Range	Resolution	Accuracy
	0.1Ω	Open circuit voltage is around 0.5V. Resistance >150Ω, buzzer will not sound. Resistance ≤10Ω, buzzer will sound. 11 < Resistance < 150.....Not Specified.
	1mV	Open-circuit voltage is around 1.5V. Normal voltage is around 0.5V to 0.8V for silicon PN junction.

Overload protection: 600V

5. Battery Test

Range	Resolution	Accuracy
1.5V	10mV	±(10%+3dgt)
9V		

Overload protection:



F1 fuse, 0.5A H 660V fast-fuse, Φ6.3x32mm (AM-500)
 F1 fuse, 0.5A H 700V fast-fuse, Φ6.3x32mm (AM-500-EUR)
 For 1.5V range: Load resistance is around 30Ω.
 For 9V range: Load resistance is around 1kΩ.

6. DC Current Measurement

Range		Resolution	Accuracy
μA	200.0 μA	0.1 μA	$\pm(1.0\%+2\text{dgt})$
	2000 μA	1 μA	
mA	20.00mA	10 μA	
	200.0mA	0.1mA	
A	2.000A	1mA	$\pm(1.2\%+3\text{dgt})$
	10.00A	10mA	

Overload protection:



mA / μA input:

F1 fuse, 0.5A H 660V fast-fuse, $\Phi 6.3 \times 32\text{mm}$ (AM-500)

F1 fuse, 0.5A H 700V fast-fuse, $\Phi 6.3 \times 32\text{mm}$ (AM-500-EUR)

10 A input:

F2 fuse, 10A H 660V fast-fuse, $\Phi 6.3 \times 32\text{mm}$ (AM-500)

F2 fuse, 10A H 600V fast-fuse, $\Phi 6 \times 25\text{mm}$ (AM-500-EUR)

7. AC Current Measurement

Range		Resolution	Accuracy
μA	200.0 μA	0.1 μA	$\pm(1.2\%+2\text{dgt})$
	2000 μA	1 μA	
mA	20.00mA	10 μA	
	200.0mA	0.1mA	
A	2.000A	1mA	$\pm(1.5\%+3\text{dgt})$
	10.00A	10mA	

Frequency response: 45Hz ~ 400Hz

Overload protection:



mA / μA input:

F1 fuse, 0.5A H 660V fast-fuse, $\Phi 6.3 \times 32\text{mm}$ (AM-500)

F1 fuse, 0.5A H 700V fast-fuse, $\Phi 6.3 \times 32\text{mm}$ (AM-500-EUR)

10 A input:

F2 fuse, 10A H 660V fast-fuse, $\Phi 6.3 \times 32$ mm (AM-500)

F2 fuse, 10A H 600V fast-fuse, $\Phi 6 \times 25$ mm (AM-500-EUR)

MAINTENANCE AND REPAIR

If the Meter fails to operate, check battery, test leads, etc., and replace as necessary.

Double check the followings:

1. Replace the fuse or battery if the meter does not work.
2. Review the operating instructions for possible mistakes in operating procedure.

Except for the replacement of the battery, repair of the meter should be performed only by an Authorized Service Center or by other qualified instrument service personnel.

The front panel and case can be cleaned with a mild solution of detergent and water.

Apply sparingly with a soft cloth and allow to dry completely before using. Do not use aromatic hydrocarbons, Gasoline or chlorinated solvents for cleaning.

BATTERY AND FUSE REPLACEMENT

⚠ ⚠ WARNING

*To avoid shock, injury, or damage to the Meter:
Disconnect test leads before opening case.
Use **ONLY** fuses with the amperage, interrupt,
voltage, and speed ratings specified.*

Replacing BATTERY follow below steps:

1. Disconnect the test lead probe from measuring circuit.
2. Turn the Meter to OFF position.
3. Remove the screws from the battery cover and open the battery cover
4. Remove the batteries and replace with two 1.5V Alkaline Batteries (AAA) or equivalent. Pay attention to the polarity signs.
5. Put the battery cover back and re-fasten the screw.

Battery: 1.5V Alkaline Batteries (AAA) or equivalent

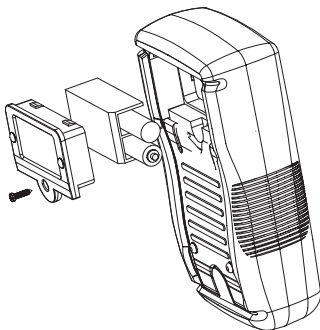

Replacing FUSE follow below steps:

1. Disconnect the test lead probe from measuring circuit.
2. Turn the Meter to OFF position and remove the holster.
3. Remove the screws from the enclosure and open the enclosure.
4. Remove the broken fuse and replace with new specified fuse.
5. Put the enclosure back and re-fasten the screw.

Fuse:

mA / μ A input:

F1 fuse, 0.5A H 660V fast-fuse, Φ 6.3x32mm (AM-500)

F1 fuse, 0.5A H 700V fast-fuse, Φ 6.3x32mm (AM-500-EUR)

10 A input:

F2 fuse, 10A H 660V fast-fuse, Φ 6.3x32mm (AM-500)

F2 fuse, 10A H 600V fast-fuse, Φ 6x25mm (AM-500-EUR)

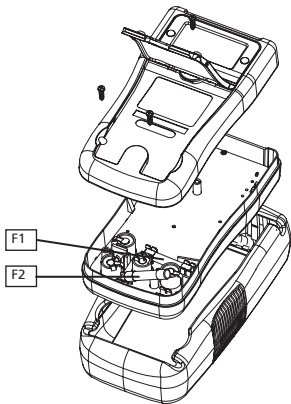

Visit www.Amprobe.com for

- **Catalog**
- **Application notes**
- **Product specifications**
- **User manuals**

Amprobe®

www.Amprobe.com

info@amprobe.com

Everett, WA 98203

Tel: 877-AMPROBE (267-7623)

Amprobe® Europe

Beha-Amprobe

In den Engematten 14

79286 Glottertal, Germany

Tel.: +49 (0) 7684 8009 - 0



Please
Recycle