

AMPROBE®

HARD AT WORK SINCE 1948.

ACD-14-PRO

ACD-14-PRO-EUR

Dual Display 600 A TRMS Clamp Multimeter

User Manual

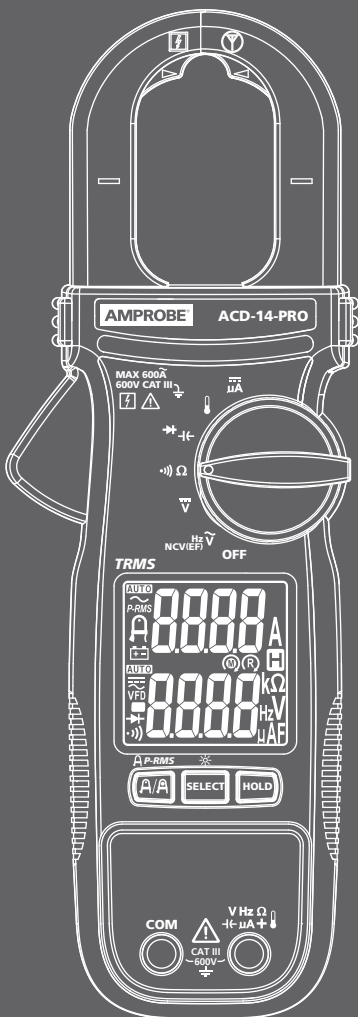

AMPROBE®

ACD-14-PRO
ACD-14-PRO-EUR
Dual Display 600 A TRMS
Clamp Multimeter

User Manual

English

Limited Warranty and Limitation of Liability

Your Amprobe product will be free from defects in material and workmanship for one year from the date of purchase unless local laws require otherwise. This warranty does not cover fuses, disposable batteries or damage from accident, neglect, misuse, alteration, contamination, or abnormal conditions of operation or handling. Resellers are not authorized to extend any other warranty on the behalf of Amprobe. To obtain service during the warranty period, return the product with proof of purchase to an authorized Amprobe Service Center or to an Amprobe dealer or distributor. See Repair Section for details. THIS WARRANTY IS YOUR ONLY REMEDY. ALL OTHER WARRANTIES - WHETHER EXPRESS, IMPLIED OR STATUTORY - INCLUDING IMPLIED WARRANTIES OF FITNESS FOR A PARTICULAR PURPOSE OR MERCHANTABILITY, ARE HEREBY DISCLAIMED. MANUFACTURER SHALL NOT BE LIABLE FOR ANY SPECIAL, INDIRECT, INCIDENTAL OR CONSEQUENTIAL DAMAGES OR LOSSES, ARISING FROM ANY CAUSE OR THEORY. Since some states or countries do not allow the exclusion or limitation of an implied warranty or of incidental or consequential damages, this limitation of liability may not apply to you.

Repair

All Amprobe returned for warranty or non-warranty repair or for calibration should be accompanied by the following: your name, company's name, address, telephone number, and proof of purchase. Additionally, please include a brief description of the problem or the service requested and include the test leads with the meter. Non-warranty repair or replacement charges should be remitted in the form of a check, a money order, credit card with expiration date, or a purchase order made payable to Amprobe.

In-warranty Repairs and Replacement – All Countries

Please read the warranty statement and check your battery before requesting repair. During the warranty period, any defective test tool can be returned to your Amprobe distributor for an exchange for the same or like product. Please check the "Where to Buy" section on www.Amprobe.com for a list of distributors near you. Additionally, in the United States and Canada, in-warranty repair and replacement units can also be sent to an Amprobe Service Center (see address below).

Non-warranty Repairs and Replacement – United States and Canada

Non-warranty repairs in the United States and Canada should be sent to an Amprobe Service Center. Call Amprobe or inquire at your point of purchase for current repair and replacement rates.

USA:

Amprobe

Everett, WA 98203

Tel: 877-AMPROBE (267-7623)

Canada:

Amprobe

Mississauga, ON L4Z 1X9

Tel: 905-890-7600

Non-warranty Repairs and Replacement – Europe

European non-warranty units can be replaced by your Amprobe distributor for a nominal charge. Please check the "Where to Buy" section on www.beha-amprobe.com for a list of distributors near you.

Amprobe Europe*

Beha-Amprobe

In den Engematten 14

79286 Glottertal, Germany

Tel.: +49 (0) 7684 8009 - 0

www.beha-amprobe.com

*(Correspondence only – no repair or replacement available from this address. European customers please contact your distributor.)

ACD-14-PRO / ACD-14-PRO-EUR
Dual Display 600 A TRMS Clamp Multimeter

CONTENTS

SYMBOL	3
SAFETY INFORMATION	4
UNPACKING AND INSPECTION	5
MEASUREMENTS	6
Measuring AC and DC Voltage	7
Voltage Detection (NCV).....	7
Measuring AC Current.....	8
Precise Low-Current Measurement	9
Microamps μ A Measurement	9
Measuring Resistance and Continuity	10
Measuring Capacitance and Diode	10
Measuring Temperature	11
Backlight	12
Auto Power OFF.....	12
SPECIFICATIONS	13
ELECTRICAL SPECIFICATIONS	14
MAINTENANCE AND REPAIR	16
BATTERY REPLACEMENT	16

ACD-14-PRO / ACD-14-PRO-EUR

Dual Display 600 A TRMS Clamp Multimeter

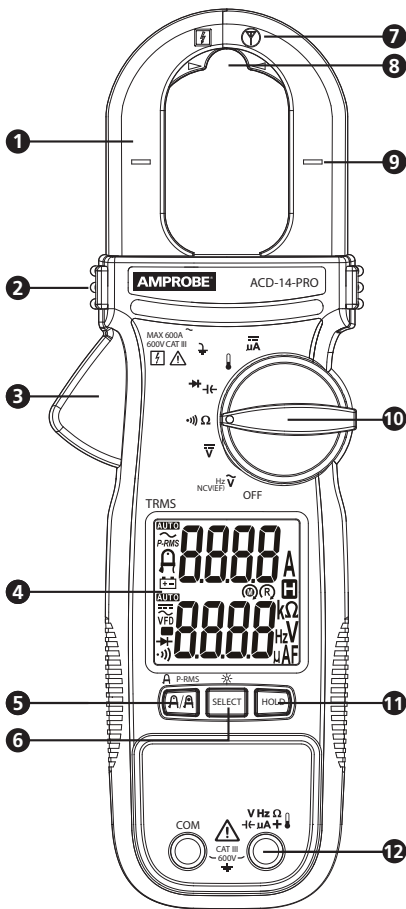



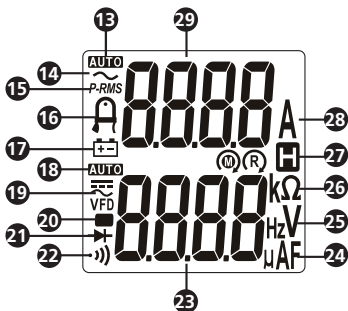

- 1** Jaw
- 2** Tactile Barrier
- 3** Jaw Release
- 4** Display
- 5** Clamp-on Current / Amp-Tip / PEAK-RMS Button
- 6** SELECT/Backlight Button
- 7** Sensor for Non-Contact Voltage Detection
- 8** Precise Low Current Measuring Location (Amp-Tip)
- 9** Indicator of the Jaw Center for Current Measurement
- 10** Rotary Switch
- 11** Data Hold Button
- 12** Input Terminals



- 13 **AUTO** Auto-ranging
- 14 \sim Alternative Current (AC)
- 15 **P-RMS**: PEAK-RMS mode (inrush current) is active
- 16 Precise low current measurement mode
- 17 Low battery indicator
- 18 **AUTO** Auto-ranging
- 19 \equiv Direct Current (DC)
 \sim Alternative Current (AC)
VFD Variable Frequency Dive
- 20 Negative reading
- 21 Diode test mode is active
- 22 Continuity buzzer is active
- 23 Lower display: Reading for V, Hz, Ω , μF , temperature and μA
- 24 μA : Microamps
 μF : Microfarads
- 25 **V**: Volts
Hz: Hertz
- 26 Ω : Ohms
k Ω : KiloOhms
- 27 **H** Data hold
- 28 **A**: Amps
- 29 Upper display: Reading for AC current

SYMBOLS

	Application around and removal from hazardous live conductors is permitted.
	Caution! Risk of electric shock.
	Caution! Refer to the explanation in this manual.
	The equipment is protected by double insulation or reinforced insulation.
	Earth (Ground).
CAT III	Measurement Category III is for equipment intended to form part of a building wiring installation. Such equipment includes socket outlets, fuse panels, and some mains installation control equipment.
\sim	Alternating Current (AC).

	Direct Current (DC).
	Battery.
	Underwriters Laboratories. [Note: Canadian and US.]
	Complies with European Directives.
	Conforms to relevant Australian standards.
	Do not dispose this product as unsorted municipal waste. Contact a qualified recycler.

SAFETY INFORMATION

The meter complies with:

- UL/IEC/EN 61010-1, CAN/CSA C22.2 No. 61010-1, Pollution Degree 2, Measurement category III 600 V
- IEC/EN 61010-2-033
- IEC/EN 61010-2-032
- IEC/EN 61010-031 (test leads)
- EMC IEC/EN 61326-1

Measurement Category III (CAT III) is for equipment intended to form part of a building wiring installation. Such equipment includes socket outlets, fuse panels, and some mains installation control equipment.

CENELEC Directives

The instruments conform to CENELEC Low-voltage directive 2006/95/EC and Electromagnetic compatibility directive 2004/108/EC.

Warning: Read Before Using

To avoid possible electric shock or personal injury:

- Use the meter only as specified in this manual or the protection provided by the meter might be impaired.
- Avoid working alone so assistance can be rendered.
- Do not use the meter in wet or dirty environments.
- Do not use the meter if it appears damaged. Inspect the meter before use. Look for cracks or missing plastic. Pay particular attention to the insulation around the connectors.
- Inspect the test leads before use. Do not use them if insulation is damaged or metal is exposed.
- Check the test leads for continuity. Replace damaged test leads before using the meter.
- Have the meter serviced only by qualified service personnel.
- Use extreme caution when working around bare conductors or bus bars. Contact with the conductor could result in electric shock.
- Do not hold the meter anywhere beyond the tactile barrier.
- When measuring current, center the conductor in the clamp.
- Do not apply more than the rated voltage, as marked on the meter, between the terminals or between any terminal and earth ground.

- Remove test leads from the meter before opening the Meter case or battery cover.
- Remove the jaw from all conductors before opening the Meter case or battery cover.
- Never operate the meter with the battery cover removed or the case open.
- Never remove the battery cover or open the case of the meter without first removing the test leads or the jaws from a live conductor.
- Use caution when working with voltages above 30 V AC rms, 42 V AC peak, or 60 V DC. These voltages pose a shock hazard.
- Do not attempt to measure any voltage that might exceed the maximum range of the meter.
- Use the proper terminals, function, and range for your measurements.
- Do not operate the meter around explosive gas, vapor, or dust.
- When using probes, never touch the probe beyond the barrier.
- When making electrical connections, connect the common test lead before connecting the live test lead; when disconnecting, disconnect the live test lead before disconnecting the common test lead.
- Disconnect circuit power and discharge all capacitors before testing resistance, continuity, capacitance or diodes
- Use only 1.5V AAA batteries, properly installed in the meter case, to power the meter.
- To avoid false readings that can lead to electrical shock and injury, replace the battery as soon as the low battery indicator () appears. Check meter operation on a known source before and after use.
- When servicing, use only specified replacement parts.
- Adhere to local and national safety codes. Individual protective equipment must be used to prevent shock and arc blast injury where hazardous live conductors are exposed.
- Only use the test lead provided with the meter or UL Listed Probe Assembly rated CAT III 600V or better.

UNPACKING AND INSPECTION

Your shipping carton should include:

- 1 Clamp multimeter
- 1 Test leads
- 1 K-type thermocouple
- 2 1.5 V AAA batteries (installed)
- 1 User manual
- 1 Carrying case







If any of these items are damaged or missing, return the complete package to the place of purchase for an exchange.

MEASUREMENTS

Warning

To avoid electric shock or personal injury:

- When measuring current, center the conductor in the clamp.
- Keep fingers behind tactile barrier.
- Use the proper function and range for measurements.
- Disconnect circuit power and discharge all capacitors before testing resistance, continuity, capacitance or diodes.
- When using probes, keep fingers behind the finger guards.
- Connecting test leads:
 - Connect the common (COM) test lead to the circuit before connecting the live lead;
 - After measurement, remove live lead before removing the common (COM) test lead from the circuit.

Button	Description
SELECT / 	<p>Press SELECT button to select the alternative measurement function on the rotary switch.</p> <p>Backlight: Press SELECT button > one second to turn ON LCD backlight. LCD backlight automatically turns OFF after approximately 20 minutes.</p> <p>When LCD backlight is ON, press SELECT button > one second manually turn OFF the backlight.</p>
HOLD	<p>Press HOLD to freeze the display reading ( is displayed) and press HOLD a second time to release the reading.</p> <p> Warning</p> <p>To avoid possible electric shock or personal injury, when Display HOLD is activated, be aware that the display will not change when you apply a different voltage.</p>
 	<p>Press  button to toggle between AC A and Amp-Tip (precise low current mode). For low current on small diameter wires (< 10mm), the best accuracy is specified near the jaw tip area.</p> <p>Press  P-RMS button > one second to enter P-RMS mode (<i>P-RMS</i> is displayed) to capture inrush current (80 ms). Press a second time > one second to exit.</p> <p>Note: Auto Power Off is automatically disabled under P-RMS mode.</p>

Measuring AC and DC Voltage

To measure AC or DC voltage:

1. Turn the rotary function switch to \tilde{V} or \bar{V} .
2. Connect the black test lead to the COM terminal and the red test lead to the V terminal. Measure the voltage by touching the probes to the desired test points of the circuit.
3. View the reading on the lower display.
4. When measuring AC voltage, press SELECT button to view the frequency reading on the lower display. (SELECT button: toggle among \tilde{V} , Hz, "EF-H" and "EF-L" modes).

AC current can be measured at the same time by using the jaws while the V/COM terminals are measuring voltage. Upper display shows AC current measurement. Also see Measuring AC Current and Precise Low Current Measurement sections.

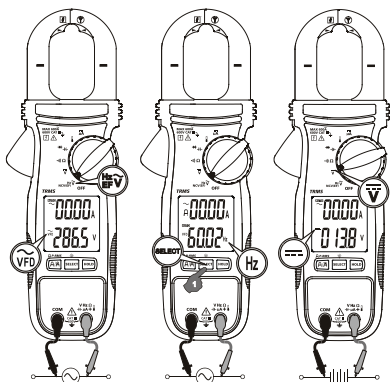

Note: AC V and Hz function are equipped with digital low pass filter, and are capable of dealing with VFD (Variable Frequency Drive) signals. It also improves AC V reading stability in noisy electrical environments.

Voltage Detection (NCV)

Non-Contact Voltage Detection:

⚠ ⚠ Warning

To avoid electrical shock and injury:

- Do not hold the meter anywhere beyond the tactile barrier.

1. Turn the rotary switch to NCV(EF) and press SELECT button to toggle to NCV(EF) mode. Two selectable sensitivity modes:
 - "EF-H" indicating high sensitivity detection mode ("EF-H" is displayed) for the application of better detecting circuit with low electric field signals.
 - "EF-L" indicating low sensitivity detection mode ("EF-L" is displayed) for the application where the electric field is too strong from the circuit under testing.Press SELECT button to toggle among \tilde{V} , Hz, "EF-H" and "EF-L" modes.

2. The voltage detection sensor  is located along the top-right end of the stationary clamp jaw for detecting electric fields surrounding energized conductors.

3. Detected electric field signal strength is indicated by a series of bar-graph segments on the lower display and beeper. The stronger the electric field detected, the more bar-graph segments are displayed and the more intense the beep sounds.

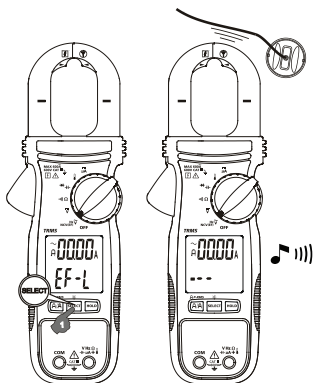

Measuring AC Current

⚠ ⚠ Warning

To avoid electrical shock and injury:

- Do not hold the meter anywhere beyond the tactile barrier.
- Do not use the meter to measure currents above the maximum rated frequency (400Hz). Circulating currents may cause the magnetic circuits of the jaws to reach hazardous excessive temperatures.

Voltage can be measured at the same time by using the V/COM terminals while the jaws are measuring current. Lower display shows voltage measurement. Also see Measuring AC and DC Voltage section.

To measure AC current:

1. Turn the rotary switch to any function to power on the meter. The default current measurement mode is AC A (upper display).
2. Open the clamp by pressing the jaw release and insert the conductor to be measured into the clamp. Ensure the jaws are firmly closed.
3. Center the conductor using the jaw alignment marks.
4. View the current reading on the upper display.

⚠ Caution

During current measurement keep the jaws away from other current-carrying devices such as transformers, motors or energized wires, as they may negatively influence accuracy of the measurement.

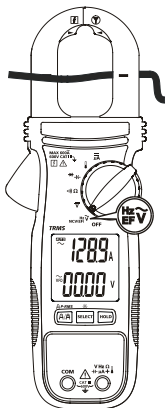

Precise Low-Current Measurement

⚠ ⚠ Warning

To avoid electrical shock and injury:

- Do not hold the meter anywhere beyond the tactile barrier.
- Do not use the meter to measure currents above the maximum rated frequency (400Hz). Circulating currents may cause the magnetic circuits of the jaws to reach hazardous excessive temperatures.

Voltage can be measured at the same time by using the V/COM terminals while the jaws are measuring current. Lower display shows voltage measurement. Also see Measuring AC and DC Voltage section.

To measure AC low-current for small conductors:

1. Turn the rotary switch to any function to power on the meter. The default current measurement mode is **AC A** (upper display). Press **A / A** button to switch between AC A and Amp-Tip mode (**A** is displayed).
2. Open the clamp by pressing the jaw release and insert the conductor to be measured into the clamp. Ensure the jaws are firmly closed.
3. Align the conductor at the specified jaw tip area for low-current measurement (Amp-Tip).
4. View the current reading on the upper display.

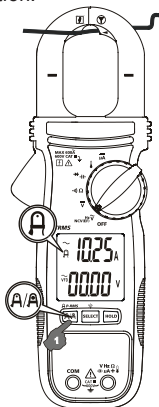

⚠ Caution

During current measurement keep the jaws away from other current-carrying devices such as transformers, motors or energized wires, as they may negatively influence accuracy of the measurement.

Microamps μA Measurement

The μA DC ($\overline{\mu\text{A}}$) function on the meter is primarily for HVAC flame sensor testing.

To test a heating system flame sensor:

1. Turn the heating unit off and locate the wire between the gas-burner controller and the flame sensor.
2. Disconnect one of the flame sensor wires.
3. Turn the rotary switch on the meter to $\overline{\mu\text{A}}$.
4. Connect the black test lead to the COM terminal and the red test lead to the μA terminal.
5. Connecting the meter in series by attaching one test lead to the disconnected flame sensor probe and the other test lead to the disconnected control-module terminal.
6. Turn heating unit on and check the reading on the Meter.
7. Refer to the heating unit documentation for what the correct reading should be.

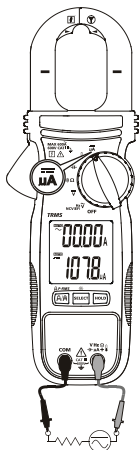

Measuring Resistance and Continuity

⚠️ ⚠️ Warning

To avoid electrical shock and injury:

- To avoid false readings and electrical shock and injury, de-energize the circuit before taking the measurement.
- To avoid electrical shock when testing resistance/continuity in a circuit, make sure the power to the circuit is turned off and all capacitors are discharged. Use DC voltage function to check the capacitors are discharged.

1. Connect the black test lead to the COM terminal and the red test lead to the Ω terminal.
2. Turn the rotary switch to $\rightarrow \Omega$ (default mode is Ω).
3. Press SELECT button switch between Ω and $\rightarrow \Omega$ function.
4. Connect the probes across the circuit or component to be tested.
5. View the reading at the lower display

Resistance measurement: The resistance reading shows on the lower display. If the circuit is open or resistance exceeds the meter's range, the display reads "OL".

Continuity measurement: The resistance reading shows on the lower display. If the circuit is shorted, the meter beeps (Beeper ON $\leq 10 \Omega$, OFF $>250 \Omega$). If the circuit is open or resistance exceeds the meter's range, the display reads OL.

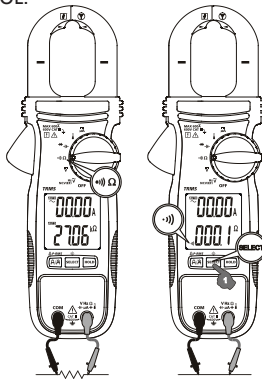

Measuring Capacitance and Diode

⚠️ ⚠️ Warning

To avoid electrical shock and injury:

- To avoid false readings and electrical shock and injury, de-energize the circuit before taking the measurement.
- To avoid electrical shock when testing capacitor/diode in a circuit, make sure the power to the circuit is turned off and all capacitors are discharged. Use DC voltage function to check the capacitors are discharged.

1. Connect the black test lead to the COM terminal and the red test lead to the \blacktriangleleft terminal.
2. Turn the rotary switch to $\blacktriangleright\blacktriangleleft$ (default mode is \blacktriangleleft).
3. Press SELECT button switch between \blacktriangleleft and \blacktriangleright function.
4. Connect the probes across the circuit or component to be tested.
5. View the reading at the lower display.

Capacitance: When measuring, be sure to note the correct polarity of the capacitor.

Testing diode: When testing diode, normal forward voltage drop (forward biased) for a good silicon diode is between 0.400V to 0.900V. A reading higher than that indicates a leaky diode (defective). A zero reading indicates a shorted diode (defective). Display reads "OL" indicates an open diode (defective).

Reverse the test leads connections (reverse biased) across the diode. The display reads "OL" if the diode is good. Any other readings indicate the diode is resistive or shorted (defective).

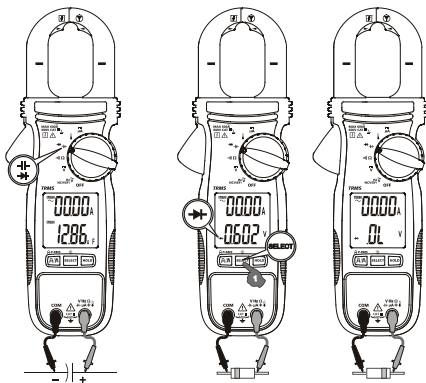

Measuring Temperature

⚠ ⚠ Warning

To avoid electrical shock and injury:

- When measuring temperature, DO NOT apply the temperature probe to any live conductive parts.

The meter measures temperature in either Celsius (°C) or Fahrenheit (°F).

1. Connect the plug of the type-K temperature probe to the meter's input terminal. Consider correct polarity of the probe.
2. Turn the rotary switch to mC .
3. Press SELECT button to select °C or °F. The display reflects the chosen temperature mode (°C or °F).
4. Position the probe to take the measurement. The reading appears on the lower display.

Note: Type-K mini plug temperature probes can also be used with a plug adaptor with 4mm pins to type-K socket.

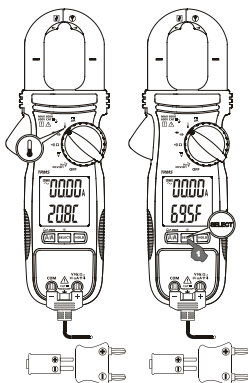

Backlight

Press SELECT button > one second to turn ON LCD backlight. LCD backlight automatically turns OFF after approximately 20 minutes.

When LCD backlight is ON, press SELECT button > one second manually turns OFF the backlight.



Auto Power OFF

The meter turns OFF if there is no button pushed, rotary function switch operation for 32 minutes and/or no specified activities below, where applicable:

1. Significant measuring readings of above 8.5% of ranges
2. Non-OL readings for Resistance, Continuity or Diode function
3. Non-zero readings for Hz function

The meter will not enter auto power OFF mode when under normal measurements. To turn the meter back ON, press the SELECT button and release, or turn the rotary switch OFF and ON to restart the meter.

SPECIFICATIONS

Display	3-5/6 digits 6000 counts; dual display
Sensing	True RMS
Polarity	Automatic
Update rate	5 per second nominal
Operating temperature	32 °F to 104 °F (0 °C to 40 °C)
Relative humidity	Maximum relative humidity 80% for temperature up to 31°C, decreasing linearly to 50% relative humidity at 40 °C
Storage temperature	-4 °F to 140 °F (-20 °C to 60 °C), < 80% R.H. (with battery removed)
Measuring category	CAT III 600 V
Pollution degree	2
Operating altitude	≤ 2000 m
Temperature coefficient	nominal 0.15 x (specified accuracy)/ °C @(0°C to 18°C or 28°C to 40°C), or otherwise specified
Transient Protection	6.0 kV (1.2/50 μs surge)
Overload protections	Current via jaws: 600 A AC rms continuous V and COM terminals: 600 V AC/DC rms
E.M.C.	Meets EN61326-1:2013 Temperature function at 80MHz ~ 150MHz, in an RF field of 1V/m: Total Accuracy = Specified Accuracy + 25 digits Other functions, in an RF field of 3V/m: Total Accuracy = Specified Accuracy + 20 digits
Agency approval	  
Power supply	Two 1.5V AAA size battery
Power consumption	6.2mA typical (backlight OFF), 62mA typical (backlight ON)
Low battery indication	Approx. 2.85 V for Capacitance & Hz; approx. 2.5 V for other functions
Auto power OFF	Idle for 32 minutes (approx.)
Auto power OFF power consumption	5μA typical
Dimension (L x W x H)	8.62 x 3.03 x 1.46 in (219 x 77 x 37 mm)
Weight	208 g (0.46 lb) with batteries installed
Jaw opening & conductor diameter	1.18 in (30 mm)

ELECTRICAL SPECIFICATIONS

Accuracy is \pm (% reading digits + number of digits) or otherwise specified at $23^{\circ}\text{C} \pm 5^{\circ}\text{C}$.

Maximum Crest Factor $< 2.5:1$ at full scale and $< 5:1$ at half scale or otherwise specified, and with frequency spectrum not exceeding the specified frequency bandwidth for non-sinusoidal waveforms.

DC Voltage

Range	Accuracy
600.0V	$\pm (1.0 \% + 5 \text{ LSD})$

Input Impedance: 10 M Ω , 100 pF nominal

AC Voltage (with Digital Low-Pass Filter)

Range	Accuracy
600.0V	$\pm (1.0 \% + 5 \text{ LSD})$

Frequency: 50 Hz to 60 Hz

Input Impedance: 10 M Ω , 100 pF nominal

Continuity

Audible Threshold: ON at $\leq 10 \Omega$; OFF at $> 250 \Omega$

Response time: 32ms approx.

Resistance

Range	Accuracy
600.0 Ω , 6.000 k Ω , 60.00 k Ω	$\pm (1.0 \% + 5 \text{ LSD})$
600.0 k Ω ¹⁾ , 6000 k Ω ²⁾	$\pm (1.2 \% + 5 \text{ LSD})$

Open Circuit Voltage: 1.7VDC typical

1) Test Current: 2 μA typical

2) Test Current: 0.2 μA typical

Capacitance

Range	Accuracy ¹⁾
200.0 μF , 2500 μF	$\pm (2.0 \% + 4 \text{ LSD})$

1)Accuracy with film capacitor or better

Diode

Range	Accuracy
3.000 V	$\pm (1.5 \% + 5 \text{ LSD})$

Test Current: 0.3mA typically

Open Circuit Voltage: $< 3.5 \text{ V}$ DC typical

DC μ A

Range	Accuracy	Burden Voltage
200.0 μ A, 2000 μ A	$\pm (1.0 \% + 5 \text{ LSD})$	3.5 mV/ μ A

Temperature

Range	Accuracy
- 40.0 °C to 99.9 °C	$\pm(1\% + 0.8 \text{ }^\circ\text{C})$
100 °C to 400 °C	$\pm(1\% + 1 \text{ }^\circ\text{C})$
-40.0 °F to 99.9 °F	$\pm(1\% + 1.5 \text{ }^\circ\text{F})$
100 °F to 752 °F	$\pm(1\% + 2 \text{ }^\circ\text{F})$

K-type thermocouple accuracy tolerances not included

Precise Low Current AC (Amp-Tip)

Range	Accuracy ^{1) 2) 3) 4)}
60.00 A	$\pm (1.5 \% + 5 \text{ LSD})$

Frequency: 50 Hz to 60 Hz

- 1) Induced error from adjacent current-carrying conductor: < 0.06 A/A
- 2) Induced error from AC V measurement < 0.60A /kV @ 50/60 Hz
- 3) Add 10 LSD to the specified accuracy @ < 6 A
- 4) Unspecified at currents < 0.2A if function continuity \bullet) or EF-Detection (NCV) is selected in the lower display.

AC Current

Range	Accuracy ^{1) 2) 3) 4)}
60.00 A ⁵⁾ , 600.0 A	$\pm (1.8 \% + 5 \text{ LSD})$ @ 50 Hz to <100 Hz
60.00 A ⁵⁾ , 600.0 A	$\pm (2.0 \% + 5 \text{ LSD})$ @ 100 Hz to 400 Hz

- 1) Induced error from adjacent current-carrying conductor: < 0.06 A/A
- 2) Induced error from AC V measurement < 0.60A /kV @ 50/60 Hz
- 3) Specified accuracy is for measurements made at the jaw center. When the conductor is not positioned at the jaw center, add 2% to specified accuracy for position errors
- 4) Unspecified at currents < 0.2A if function continuity \bullet) or EF-Detection (NCV) is selected in the lower display.
- 5) Add 10 LSD to specified accuracy @ < 6 A

PEAK-rms (for AC A function)

Response: 80 ms to > 90 %

Frequency Hz

Function	Sensitivity ¹⁾ (Sine rms)	Range
600 V	50 V	5.00 Hz to 999.9 Hz

Accuracy: $\pm (1.0 \% + 5 \text{ LSD})$

¹⁾ DC-bias, if any, not more than 50% of Sine rms

Voltage Detection (NCV)

Bar-graph Indication	EF-H (High sensitivity) Typical Voltage (Tolerance)	EF-L (Low sensitivity) Typical Voltage (Tolerance)
-	10 V (5 V to 25 V)	40 V (32 V to 70 V)
--	25 V (20 V to 66 V)	110 V (55 V to 165 V)
---	55 V (50 V to 125 V)	220 V (130 V to 265 V)
----	110 V (90 V to 200 V)	400 V (250 V to 500 V)
-----	220 V (>180 V)	550 V (>430 V)

Indication: bar-graph segments and audible beep tones proportional to the field strength

Detection frequency: 50/60 Hz

Detection sensor: inside the top side of the stationary jaw

MAINTENANCE AND REPAIR

If the meter fails to operate, check battery, test leads, etc., and replace as necessary.

Double check the following:

1. Replace the fuse or battery if the meter does not work.
2. Review the operating instructions for possible mistakes in operating procedure.

Except for the replacement of the battery, repair of the meter should be performed only by a Factory Authorized Service Center or by other qualified instrument service personnel.

The front panel and case can be cleaned with a mild solution of detergent and water. Apply sparingly with a soft cloth and allow to dry completely before using. Do not use aromatic hydrocarbons, gasoline or chlorinated solvents for cleaning.

BATTERY REPLACEMENT

When battery voltage drops below the value required for proper operation, the battery symbol () appears.

Warning

To avoid shock, injury, or damage to the meter, disconnect test leads before opening case.

Replacing BATTERY follow below steps:

1. Disconnect the test lead probe from all measuring circuits and/or remove the jaw from all conductors.
2. Turn the meter to OFF position.
3. Remove the screws from the battery cover and open the battery cover.
4. Remove the batteries and replace with 1.5V AAA size (IEC R03). Observe correct polarity when installing the batteries.
5. Put the battery cover back and re-fasten the screw.

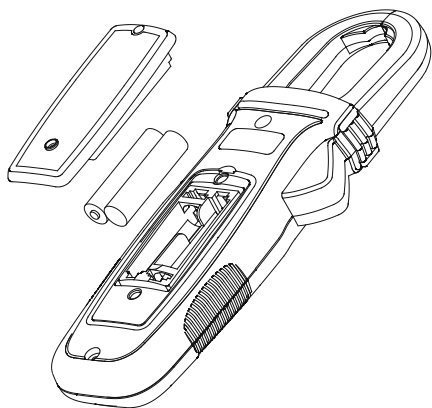

Visit www.Amprobe.com for

- **Catalog**
- **Application notes**
- **Product specifications**
- **User manuals**

Amprobe®

www.Amprobe.com

info@amprobe.com

Everett, WA 98203

Tel: 877-AMPROBE (267-7623)

Amprobe® Europe

Beha-Amprobe

In den Engematten 14

79286 Glottertal, Germany

Tel.: +49 (0) 7684 8009 - 0



Please
Recycle